

ARM[®] Cortex[®]-M3 Processor

Revision: r2p1

Technical Reference Manual



ARM® Cortex®-M3 Processor

Technical Reference Manual

Copyright © 2005-2008, 2010, 2015 ARM. All rights reserved.

Release Information

Document History

Issue	Date	Confidentiality	Change
A	15 December 2005	Confidential	First Release
B	13 January 2006	Non-Confidential	Confidentiality status amended
C	10 May 2006	Non-Confidential	First Release for r1p0
D	27 September 2006	Non-Confidential	First Release for r1p1
E	13 June 2007	Non-Confidential	Minor update with no technical changes
F	11 April 2008	Confidential	Limited release for SC300 r0p0
G	26 June 2008	Non-Confidential	First Release for r2p0
H	26 February 2010	Non-Confidential	Second Release for r2p0
I	07 July 2010	Non-Confidential	First Release for r2p1
0201-00	24 February 2015	Non-Confidential	Document source updated to comply with DITA standards. Document number changed to 100165. DITA-XML.

Non-Confidential Proprietary Notice

This document is protected by copyright and other related rights and the practice or implementation of the information contained in this document may be protected by one or more patents or pending patent applications. No part of this document may be reproduced in any form by any means without the express prior written permission of ARM. **No license, express or implied, by estoppel or otherwise to any intellectual property rights is granted by this document unless specifically stated.**

Your access to the information in this document is conditional upon your acceptance that you will not use or permit others to use the information for the purposes of determining whether implementations infringe any third party patents.

THIS DOCUMENT IS PROVIDED “AS IS”. ARM PROVIDES NO REPRESENTATIONS AND NO WARRANTIES, EXPRESS, IMPLIED OR STATUTORY, INCLUDING, WITHOUT LIMITATION, THE IMPLIED WARRANTIES OF MERCHANTABILITY, SATISFACTORY QUALITY, NON-INFRINGEMENT OR FITNESS FOR A PARTICULAR PURPOSE WITH RESPECT TO THE DOCUMENT. For the avoidance of doubt, ARM makes no representation with respect to, and has undertaken no analysis to identify or understand the scope and content of, third party patents, copyrights, trade secrets, or other rights.

This document may include technical inaccuracies or typographical errors.

TO THE EXTENT NOT PROHIBITED BY LAW, IN NO EVENT WILL ARM BE LIABLE FOR ANY DAMAGES, INCLUDING WITHOUT LIMITATION ANY DIRECT, INDIRECT, SPECIAL, INCIDENTAL, PUNITIVE, OR CONSEQUENTIAL DAMAGES, HOWEVER CAUSED AND REGARDLESS OF THE THEORY OF LIABILITY, ARISING OUT OF ANY USE OF THIS DOCUMENT, EVEN IF ARM HAS BEEN ADVISED OF THE POSSIBILITY OF SUCH DAMAGES.

This document consists solely of commercial items. You shall be responsible for ensuring that any use, duplication or disclosure of this document complies fully with any relevant export laws and regulations to assure that this document or any portion thereof is not exported, directly or indirectly, in violation of such export laws. Use of the word “partner” in reference to ARM’s customers is not intended to create or refer to any partnership relationship with any other company. ARM may make changes to this document at any time and without notice.

If any of the provisions contained in these terms conflict with any of the provisions of any signed written agreement covering this document with ARM, then the signed written agreement prevails over and supersedes the conflicting provisions of these terms. This document may be translated into other languages for convenience, and you agree that if there is any conflict between the English version of this document and any translation, the terms of the English version of the Agreement shall prevail.

Words and logos marked with ® or ™ are registered trademarks or trademarks of ARM Limited or its affiliates in the EU and/or elsewhere. All rights reserved. Other brands and names mentioned in this document may be the trademarks of their respective owners. Please follow ARM's trademark usage guidelines at <http://www.arm.com/about/trademark-usage-guidelines.php>

Copyright © [2005-2008, 2010, 2015], ARM Limited or its affiliates. All rights reserved.

ARM Limited. Company 02557590 registered in England.

110 Fulbourn Road, Cambridge, England CB1 9NJ.

LES-PRE-20349

Confidentiality Status

This document is Non-Confidential. The right to use, copy and disclose this document may be subject to license restrictions in accordance with the terms of the agreement entered into by ARM and the party that ARM delivered this document to.

Unrestricted Access is an ARM internal classification.

Product Status

The information in this document is Final, that is for a developed product.

Web Address

<http://www.arm.com>

Contents

ARM® Cortex®-M3 Processor Technical Reference Manual

Preface

<i>About this book</i>	7
<i>Feedback</i>	10

Chapter 1

Introduction

1.1	<i>About the processor</i>	1-12
1.2	<i>Processor features list</i>	1-13
1.3	<i>External interfaces</i>	1-14
1.4	<i>Optional implementation components</i>	1-15
1.5	<i>Product documentation</i>	1-16
1.6	<i>Product revisions</i>	1-19

Chapter 2

Functional Description

2.1	<i>About the functions</i>	2-22
2.2	<i>Processor features list</i>	2-23
2.3	<i>Interfaces</i>	2-25

Chapter 3

Programmers Model

3.1	<i>About the programmers' model</i>	3-29
3.2	<i>Modes of operation and execution</i>	3-30
3.3	<i>Instruction set summary</i>	3-31
3.4	<i>Processor memory model</i>	3-37

3.5	<i>Write buffer</i>	3-40
3.6	<i>Exclusive monitor</i>	3-41
3.7	<i>Bit-banding</i>	3-42
3.8	<i>Processor core register summary</i>	3-44
3.9	<i>Exceptions</i>	3-46
Chapter 4	System Control	
4.1	<i>System control registers</i>	4-49
4.2	<i>Auxiliary Control Register, ACTLR</i>	4-51
4.3	<i>CPUID Base Register, CPUID</i>	4-52
4.4	<i>Auxiliary Fault Status Register, AFSR</i>	4-53
Chapter 5	Memory Protection Unit	
5.1	<i>About the MPU</i>	5-55
5.2	<i>MPU functional description</i>	5-56
5.3	<i>MPU programmers model table</i>	5-57
Chapter 6	Nested Vectored Interrupt Controller	
6.1	<i>NVIC functional description</i>	6-59
6.2	<i>NVIC programmers' model</i>	6-60
Chapter 7	Debug	
7.1	<i>Debug configuration</i>	7-63
7.2	<i>AHB-AP debug access port</i>	7-67
7.3	<i>Flash Patch and Breakpoint Unit (FPB)</i>	7-70
Chapter 8	Data Watchpoint and Trace Unit	
8.1	<i>DWT functional description</i>	8-73
8.2	<i>DWT Programmers' model</i>	8-74
Chapter 9	Instrumentation Trace Macrocell Unit	
9.1	<i>ITM functional description</i>	9-77
9.2	<i>ITM programmers' model</i>	9-78
9.3	<i>ITM Trace Privilege Register, ITM_TPR</i>	9-79
Chapter 10	Embedded Trace Macrocell	
10.1	<i>About the ETM</i>	10-81
10.2	<i>ETM functional description</i>	10-82
10.3	<i>ETM Programmers model</i>	10-88
Chapter 11	Trace Port Interface Unit	
11.1	<i>About the TPIU</i>	11-104
11.2	<i>TPIU functional description</i>	11-105
11.3	<i>TPIU programmers model</i>	11-107
Appendix A	Revisions	
A.1	<i>Revisions</i>	Appx-A-117

Preface

This preface introduces the *ARM® Cortex®-M3 Processor Technical Reference Manual*.

It contains the following:

- *About this book* on page 7.
- *Feedback* on page 10.

About this book

This book contains documentation for the Cortex-M3 processor, describing the programmers model, instructions, registers, memory map, cache and debug support. Components include ETM, MPU, NVIC, FPB, DWT, ITM, AHB, and TPIU.

Product revision status

The *mpn* identifier indicates the revision status of the product described in this book, for example, r1p2, where:

rm Identifies the major revision of the product, for example, r1.

pn Identifies the minor revision or modification status of the product, for example, p2.

Intended audience

This manual is written to help system designers, system integrators, verification engineers, and software programmers who are implementing a System-on-Chip (SoC) device based on the Cortex[®]-M3 processor.

Using this book

This book is organized into the following chapters:

Chapter 1 Introduction

This chapter introduces the processor and processor instruction set.

Chapter 2 Functional Description

This chapter introduces the processor and its external interfaces.

Chapter 3 Programmers Model

This chapter describes the processor programmers model.

Chapter 4 System Control

This chapter provides a summary of the system control registers whose implementation is specific to the Cortex-M3 processor.

Chapter 5 Memory Protection Unit

This chapter describes the processor Memory Protection Unit (MPU).

Chapter 6 Nested Vectored Interrupt Controller

This chapter describes the *Nested Vectored Interrupt Controller* (NVIC). The NVIC provides configurable interrupt handling abilities to the processor, facilitates low-latency exception and interrupt handling, and controls power management.

Chapter 7 Debug

This chapter describes how to debug and test software running on the processor.

Chapter 8 Data Watchpoint and Trace Unit

This chapter describes the Data Watchpoint and Trace (DWT) unit.

Chapter 9 Instrumentation Trace Macrocell Unit

This chapter describes the Instrumentation Trace Macrocell (ITM) unit.

Chapter 10 Embedded Trace Macrocell

This chapter describes the Embedded Trace Macrocell (ETM).

Chapter 11 Trace Port Interface Unit

This chapter describes the Trace Port Interface Unit (TPIU) specific to this processor.

Appendix A Revisions

The technical changes between released issues of this book.

Glossary

The ARM Glossary is a list of terms used in ARM documentation, together with definitions for those terms. The ARM Glossary does not contain terms that are industry standard unless the ARM meaning differs from the generally accepted meaning.

See the *ARM Glossary* for more information.

Typographic conventions

italic

Introduces special terminology, denotes cross-references, and citations.

bold

Highlights interface elements, such as menu names. Denotes signal names. Also used for terms in descriptive lists, where appropriate.

monospace

Denotes text that you can enter at the keyboard, such as commands, file and program names, and source code.

monospace

Denotes a permitted abbreviation for a command or option. You can enter the underlined text instead of the full command or option name.

monospace italic

Denotes arguments to monospace text where the argument is to be replaced by a specific value.

monospace bold

Denotes language keywords when used outside example code.

<and>

Encloses replaceable terms for assembler syntax where they appear in code or code fragments. For example:

```
MRC p15, 0 <Rd>, <CRn>, <CRm>, <Opcode_2>
```

SMALL CAPITALS

Used in body text for a few terms that have specific technical meanings, that are defined in the *ARM glossary*. For example, IMPLEMENTATION DEFINED, IMPLEMENTATION SPECIFIC, UNKNOWN, and UNPREDICTABLE.

Timing diagrams

The following figure explains the components used in timing diagrams. Variations, when they occur, have clear labels. You must not assume any timing information that is not explicit in the diagrams.

Shaded bus and signal areas are undefined, so the bus or signal can assume any value within the shaded area at that time. The actual level is unimportant and does not affect normal operation.

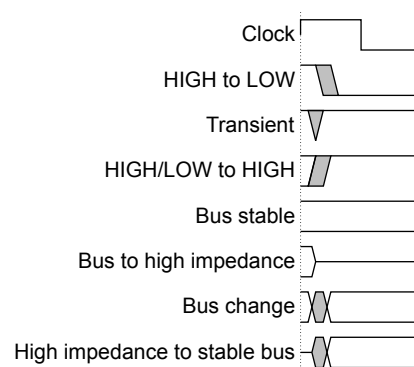

Figure 1 Key to timing diagram conventions

Signals

The signal conventions are:

Signal level

The level of an asserted signal depends on whether the signal is active-HIGH or active-LOW. Asserted means:

- HIGH for active-HIGH signals.
- LOW for active-LOW signals.

Lower-case n

At the start or end of a signal name denotes an active-LOW signal.

Additional reading

This book contains information that is specific to this product. See the following documents for other relevant information.

ARM publications

- ARMv7-M Architecture Reference Manual (ARM DDI 0403).
- ARM® Cortex-M3 Integration and Implementation Manual (ARM DII 0240).
- ARM AMBA® 3 AHB-Lite Protocol (v1.0) (ARM IHI 0033).
- ARM AMBA 3 APB Protocol Specification (ARM IHI 0024).
- AMBA 3 ATB Protocol Specification (ARM IHI 0032).
- ARM CoreSight™ Components Technical Reference Manual (ARM DDI 0314).
- ARM Debug Interface v5 Architecture Specification (ARM IHI 0031).
- ARM Embedded Trace Macrocell Architecture Specification (ARM IHI 0014).

Other publications

This section lists relevant documents published by third parties:

- IEEE Standard Test Access Port and Boundary-Scan Architecture 1149.1-2001 (JTAG).

Feedback

Feedback on this product

If you have any comments or suggestions about this product, contact your supplier and give:

- The product name.
- The product revision or version.
- An explanation with as much information as you can provide. Include symptoms and diagnostic procedures if appropriate.

Feedback on content

If you have comments on content then send an e-mail to errata@arm.com. Give:

- The title.
- The number ARM 100165_0201_00_en.
- The page number(s) to which your comments refer.
- A concise explanation of your comments.

ARM also welcomes general suggestions for additions and improvements.

————— **Note** —————

ARM tests the PDF only in Adobe Acrobat and Acrobat Reader, and cannot guarantee the quality of the represented document when used with any other PDF reader.

Chapter 1

Introduction

This chapter introduces the processor and processor instruction set.

It contains the following sections:

- *1.1 About the processor* on page 1-12.
- *1.2 Processor features list* on page 1-13.
- *1.3 External interfaces* on page 1-14.
- *1.4 Optional implementation components* on page 1-15.
- *1.5 Product documentation* on page 1-16.
- *1.6 Product revisions* on page 1-19.

1.1 About the processor

The Cortex-M3 is a low-power processor that features low gate count, low interrupt latency, and low-cost debug. It is intended for deeply embedded applications that require optimal interrupt response features.

1.2 Processor features list

The processor includes a core, a Nested Vectored Interrupt Controller (NVIC), high-performance bus interfaces, and other features.

The processor incorporates the following features:

- A processor core.
- A *Nested Vectored Interrupt Controller* (NVIC) closely integrated with the processor core to achieve low latency interrupt processing.
- Multiple high-performance bus interfaces.
- A low-cost debug solution with the optional ability to:
 - Implement breakpoints and code patches.
 - Implement watchpoints, tracing, and system profiling.
 - Support `printf()` style debugging.
 - Bridge to a *Trace Port Analyzer* (TPA).
- An optional *Memory Protection Unit* (MPU).

1.3 External interfaces

The processor incorporates three external bus interfaces, an ETM interface that allows the connection of an Embedded Trace Macrocell, an AHB Trace Macrocell interface that enables simple connection of an ETM to the processor, and an Advanced High-performance Bus Access Port (AHB-AP) interface for debug accesses.

The processor incorporates the following external interfaces:

- Multiple memory and device bus interfaces.
- ETM interface.
- Trace port interface.
- Debug port interface.

1.4 Optional implementation components

You can configure your processor implementation to include optional components. For example, a Memory Protection Unit (MPU), Flash Patch and Breakpoint (FPB), and Data Watchpoint and Trace Unit (DWT).

The full list of Cortex-M3 optional implementation components is:

- Memory Protection Unit (MPU).
- Flash Patch and Breakpoint (FPB).
- Data Watchpoint and Trace Unit (DWT).
- Instrumentation Trace Macrocell Unit (ITM).
- Embedded Trace Macrocell (ETM).
- Advanced High-performance Bus Access Port (AHB-AP).
- AHB Trace Macrocell interface (HTM interface).
- Trace Port Interface Unit (TPIU).
- Wake-up Interrupt Controller (WIC).
- Debug Port Debug Port AHB-AP interface.
- Constant AHB control.

Note

You can only configure trace functionality in the following combinations:

- No trace functionality.
- ITM and DWT.
- ITM, DWT, and ETM.
- ITM, DWT, ETM, and HTM.

You can configure the debug features provided in the DWT independently.

1.5 Product documentation

The information supplied with this product includes a Technical Reference Manual, an Integration and Implementation manual, together with design flow, architecture, and protocol information.

This section contains the following subsections:

- [1.5.1 Reference manuals on page 1-16.](#)
- [1.5.2 Design Flow on page 1-17.](#)
- [1.5.3 Architecture and protocol information on page 1-18.](#)

1.5.1 Reference manuals

This product is supplied with a complete set of reference manuals that describe processor functionality, build configuration options, and reference material that ARM partners might want to include in their own processor user guides.

Technical Reference Manual

The *Technical Reference Manual* (TRM) describes the functionality and the effects of functional options on the behavior of the Cortex-M3 processor. It is required at all stages of the design flow. Some behavior described in the TRM might not be relevant because of the way that the Cortex-M3 processor is implemented and integrated. If you are programming the Cortex-M3 processor then contact:

- The implementer to determine:
 - The build configuration of the implementation.
 - What integration, if any, was performed before implementing the processor.
- The integrator to determine the pin configuration of the SoC that you are using.

Integration and Implementation Manual

The *Integration and Implementation Manual* (IIM) describes:

- The available build configuration options and related issues in selecting them.
- How to configure the *Register Transfer Level* (RTL) with the build configuration options.
- How to integrate the processor into a SoC. This includes a description of the integration kit and describes the pins that the integrator must tie off to configure the macrocell for the required integration.
- How to implement the processor into your design. This includes floorplanning guidelines, Design for Test (DFT) information, and how to perform netlist dynamic verification on the processor.
- The processes to sign off the integration and implementation of the design.

The ARM product deliverables include reference scripts and information about using them to implement your design.

Reference methodology documentation from your EDA tools vendor complements the IIM.

The IIM is a confidential book that is only available to licensees.

ETM-M4 Technical Reference Manual

The ETM-M4 TRM describes the functionality and behavior of the Cortex-M3 Embedded Trace Macrocell. It is required at all stages of the design flow. Typically the ETM-M4 is integrated with the Cortex-M3 processor prior to implementation as a single macrocell.

Cortex-M3 User Guide Reference Material

This document provides reference material that ARM partners can configure and include in a User Guide for an ARM Cortex-M3 processor. Typically:

- Each chapter in this reference material might correspond to a section in the User Guide.
- Each top-level section in this reference material might correspond to a chapter in the User Guide.

However, you can organize this material in any way, subject to the conditions of the license agreement under which ARM supplied the material.

1.5.2 Design Flow

The design flow includes steps for implementation, integration, and programming. These processes must be completed before the processor is ready for operation.

The processor is delivered as synthesizable RTL. Before it can be used in a product, it must go through the following process:

Implementation

The implementer configures the RTL and may synthesize it to produce a hard macrocell or may synthesize the whole design after implementation.

Integration

The integrator connects the implemented design into a SoC. This includes connecting it to a memory system and peripherals.

Programming

The system programmer develops the software required to configure and initialize the processor, and tests the required application software.

Each stage in the process can be performed by a different party. Implementation and integration choices affect the behavior and features of the processor.

For MCUs, often a single design team integrates the processor before synthesizing the complete design. Alternatively, the team can synthesize the processor on its own or partially integrated, to produce a macrocell that is then integrated, possibly by a separate team.

The operation of the final device depends on:

Build configuration

The implementer chooses the options that affect how the RTL source files are pre-processed. These options usually include or exclude logic that affects one or more of the area, maximum frequency, and features of the resulting macrocell.

Configuration inputs

The integrator configures some features of the processor by tying inputs to specific values. These configurations affect the start-up behavior before any software configuration is made. They can also limit the options available to the software.

Software configuration

The programmer configures the processor by programming particular values into registers. This affects the behavior of the processor.

Note

This manual refers to implementation-defined features that are applicable to build configuration options. Reference to a feature that is included means that the appropriate build and pin configuration options are selected. Reference to an enabled feature means one that has also been configured by software.

1.5.3 Architecture and protocol information

The processor complies with specifications for ARM and bus architecture, debug, and Embedded Trace Macrocell.

This book complements architecture reference manuals, architecture specifications, protocol specifications, and relevant external standards. It does not duplicate information from these sources.

ARM® architecture

The processor implements the ARMv7-M architecture profile.

For more information about the ARMv7-M architecture profile, see the *ARMv7-M Architecture Reference Manual*.

Bus architecture

The processor uses the AMBA 3 APB protocol to implement an interface for CoreSight and other debug components.

For more information about bus architecture, refer to the following manuals:

- The *ARM AMBA 3 AHB-Lite Protocol (v1.0)*.
- The *ARM AMBA 3 APB Protocol Specification*.

Debug

The processor uses the ARM debug interface architecture to implement debug features.

For more information about the debug features, refer to the following manuals:

- *ARM® Debug Interface v5 Architecture Specification*.
- *ARMv7-M Architecture Reference Manual*.

Embedded Trace Macrocell

The processor uses version 3.4 of the ARM Embedded Trace Macrocell architecture to implement trace features.

For more information about the trace features, refer to the *ARM® Embedded Trace Macrocell Architecture Specification* manual.

1.6 Product revisions

This section lists the differences in functionality between product revisions.

This section contains the following subsections:

- [1.6.1 List of differences in functionality between r0p0 and r1p0](#) on page 1-19.
- [1.6.2 List of differences in functionality between r1p0 and r1p1](#) on page 1-19.
- [1.6.3 List of differences in functionality between r1p1 and r2p0](#) on page 1-19.
- [1.6.4 List of differences in functionality between r2p0 and r2p1](#) on page 1-20.

1.6.1 List of differences in functionality between r0p0 and r1p0

Summary of differences between revisions r0p0 and r1p0.

- Addition of configurable data value comparison to the DWT module.
- Addition of a MATCHED bit to **DWT_FUNCTION**.
- Addition of configurable **ETMFIFOFULL** stalling functionality to the processor and the ETM.
- Addition of SWV Mode to the ITM.
- CPUID Base Register VARIANT field changed to indicate Rev1.
- Cortex-M3 Rev0 Bit-band accesses in BE8 mode required access sizes to be byte. Cortex-M3 Rev1 has been changed so that BE8 bit-band accesses function with any access size.
- Addition of a configuration bit called STKALIGN to ensure that all exceptions have eight-byte stack alignment.
- Addition of the Auxiliary Fault Status Register at address 0xE000ED3C. To set this register, a 32-bit input bus called **AUXFAULT** has been added.
- Addition of HTM support.
- ICode and DCode cacheable and bufferable HPROT values permanently tied to write-through.
- Addition of the SWJ-DP. This is the standard CoreSight debug port that combines JTAG-DP and SW-DP.
- Addition of DWT_PCSR Register at address 0xE000101C.
- Errata fixes to the r0p0 release.

1.6.2 List of differences in functionality between r1p0 and r1p1

Summary of differences between revisions r1p0 and r1p1.

- Data value matching for watchpoint generation has been made implementation time configurable.
- Architectural clock gating in the ETM is configurable at implementation.
- **DAPCLKEN** was required to be a static signal in r0p0 and r1p0. This requirement has been removed for r1p1.
- **SLEEPING** signal is now suppressed until the current outstanding instruction fetch has completed.
- Errata fixes to the r1p0 release.

1.6.3 List of differences in functionality between r1p1 and r2p0

Summary of differences between r1p1 and r2p0.

- Implementation time options have been added to select between different levels of debug and trace support. This has replaced the previous TIEOFF_FP BEN and TIEOFF_TRCENA options.
- New implementation option to enable the resetting of all registers within the processor.
- Architectural clock gating inclusion is now controlled using one implementation option.
- **DBGRESTART** input and **DBGRESTARTED** output have been added for use in debugging multi-core systems. See the *ARMv7-M Architecture Reference Manual* for more information.
- **SLEEPHOLDREQn** input and **SLEEPHOLDACKn** have been added to enable the extension of SLEEPING.
- The APB interface has been upgraded from v2.0 to v3.0.

- A new output signal called **INTERNALSTATE** has been added that enables observation of some of the internal state of the core if the OBSERVATION implementation option is used.
- Added support for fault-robust implementations.
- An Auxiliary Control Register has been added with new functionality disable bits that:
 - Stop interruption of load/store multiples, divides and multiplies.
 - Stop IT folding.
 - Disable the write buffers in Cortex-M3 for default memory map accesses.
- The STKALIGN bit reset value in the Configuration and Control Register at address 0xE000ED14 has been inverted. The reset value is now 1, which means that the stack frame is 8-byte aligned by default.
- Addition of a Wake-up Interrupt Controller to minimize logic in the always clocked domain during sleep.
- Addition of **FIXHMASTERTYPE** pin to prevent debugger marking AHB transactions as core data side if required.
- Improved sequential information for data accesses. Before r2p0 HPROT for sequential data accesses would change from SEQ to NSEQ if wait-states were inserted for the previous access. r2p0 maintains the SEQ information.
- Errata fixes to the r1p1 release.

1.6.4 List of differences in functionality between r2p0 and r2p1

Summary of differences between revisions r2p0 and r2p1.

- New implementation option to ensure constant AHB control during wait-stated transfers.
- New implementation option to remove the bit-banding logic.
- **MPUDISABLE** input added to disable the MPU using hardware.
- **DBGEN** input added as master debug enable. If de-asserted then debug is disabled.
- ETM upgraded from ARM ETM architecture v3.4 to v3.5 to include global time-stamping.
- The Vector Table Offset Register located at address 0xE000ED08 has been increased by two bits from 29:7 to 31:7.
- ROM table identification registers have been updated.
- Verilog file and module names have been modified. The top module names for Cortex-M3 and the integration layer are now in capitals: CORTEXM3 and CORTEXM3INTEGRATION.
- The ETM license define name has changed to ARM_CM3_ETM_LICENSE and is now defined in cm3_lic_defs.v rather than in the integration level.
- Watchpoints no longer occur if the transaction is aborted by the MPU.
- Errata fixes to the r2p0 release.

Related references

[ROM table identification and entries.](#)

Chapter 2

Functional Description

This chapter introduces the processor and its external interfaces.

It contains the following sections:

- [2.1 About the functions](#) on page 2-22.
- [2.2 Processor features list](#) on page 2-23.
- [2.3 Interfaces](#) on page 2-25.

2.1 About the functions

Block diagram of the processor, showing main functional components and interfaces.

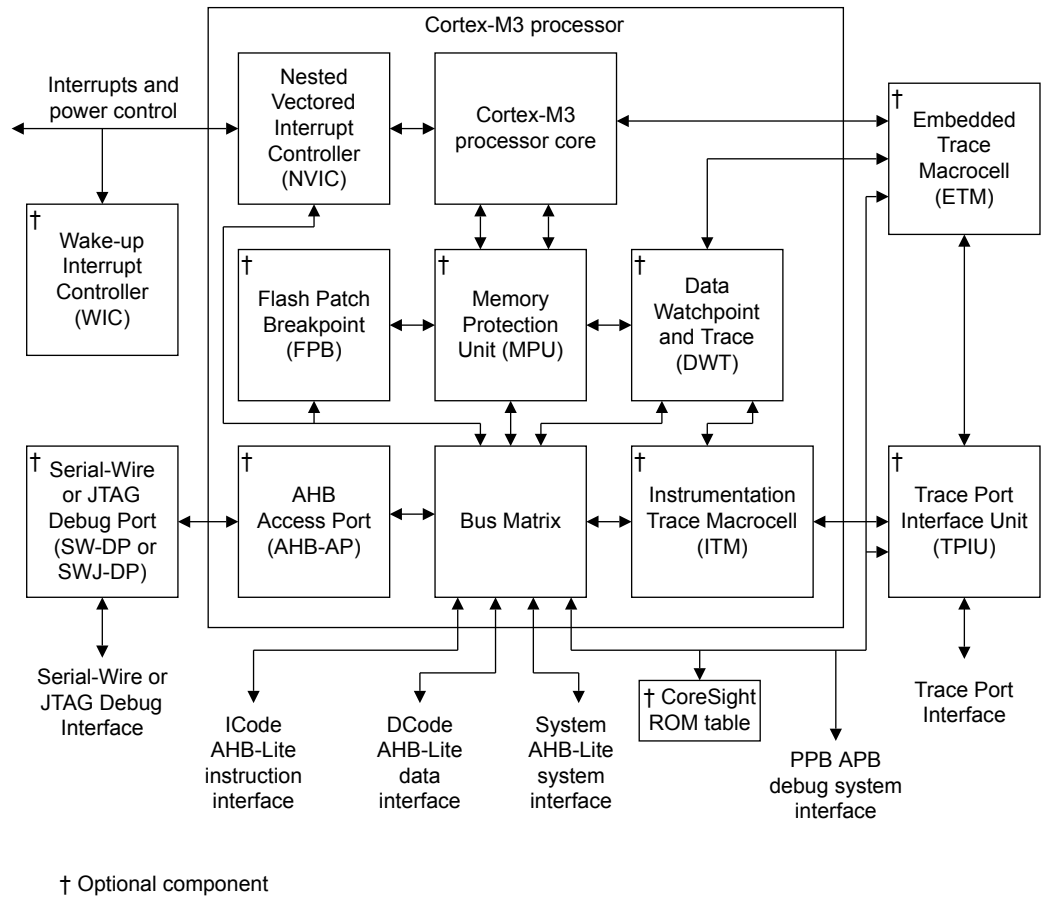

Figure 2-1 Cortex-M3 block diagram

2.2 Processor features list

The processor features list includes a low gate count processor core, an optional memory protection unit, a low-cost debug solution, together with bus interfaces that includes three Advanced High-performance Bus-Lite (AHB-Lite) interfaces and a Private Peripheral Bus (PPB).

The processor features list comprises:

- A low gate count processor core, with low latency interrupt processing that has:
 - A subset of the Thumb instruction set, defined in the *ARMv7-M Architecture Reference Manual*.
 - Banked *Stack Pointer* (SP).
 - Hardware integer divide instructions, SDIV and UDIV.
 - Handler and Thread modes.
 - Thumb and Debug states.
 - Support for interruptible-continued instructions LDM, STM, PUSH, and POP for low interrupt latency.
 - Automatic processor state saving and restoration for low latency *Interrupt Service Routine* (ISR) entry and exit.
 - Support for ARMv6 big-endian byte-invariant or little-endian accesses.
 - Support for ARMv6 unaligned accesses.
- *Nested Vectored Interrupt Controller* (NVIC) closely integrated with the processor core to achieve low latency interrupt processing. Features include:
 - External interrupts, configurable from 1 to 240.
 - Bits of priority, configurable from 3 to 8.
 - Dynamic reprioritization of interrupts.
 - Priority grouping. This enables selection of preempting interrupt levels and non preempting interrupt levels.
 - Support for tail-chaining and late arrival of interrupts. This enables back-to-back interrupt processing without the overhead of state saving and restoration between interrupts.
 - Processor state automatically saved on interrupt entry, and restored on interrupt exit, with no instruction overhead.
 - Optional *Wake-up Interrupt Controller* (WIC), providing ultra-low power sleep mode support.
- *Memory Protection Unit* (MPU). An optional MPU for memory protection, including:
 - Eight memory regions.
 - *Sub Region Disable* (SRD), enabling efficient use of memory regions.
 - The ability to enable a background region that implements the default memory map attributes.
- Bus interfaces:
 - Three *Advanced High-performance Bus-Lite* (AHB-Lite) interfaces: ICode, DCode, and System bus interfaces.
 - *Private Peripheral Bus* (PPB) based on *Advanced Peripheral Bus* (APB) interface.
 - Bit-band support that includes atomic bit-band write and read operations.
 - Memory access alignment.
 - Write buffer for buffering of write data.
 - Exclusive access transfers for multiprocessor systems.
- Low-cost debug solution that features:
 - Debug access to all memory and registers in the system, including access to memory mapped devices, access to internal core registers when the core is halted, and access to debug control registers even while **SYSRESETn** is asserted.
 - *Serial Wire Debug Port* (SW-DP) or *Serial Wire JTAG Debug Port* (SWJ-DP) debug access.
 - Optional *Flash Patch and Breakpoint* (FPB) unit for implementing breakpoints and code patches.
 - Optional *Data Watchpoint and Trace* (DWT) unit for implementing watchpoints, data tracing, and system profiling.
 - Optional *Instrumentation Trace Macrocell* (ITM) for support of printf() style debugging.

- Optional *Trace Port Interface Unit* (TPIU) for bridging to a *Trace Port Analyzer* (TPA), including *Single Wire Output* (SWO) mode.
- Optional *Embedded Trace Macrocell* (ETM) for instruction trace.

2.3 Interfaces

The processor incorporates three external bus interfaces, an ETM interface that allows the connection of an Embedded Trace Macrocell, an AHB Trace Macrocell interface that enables simple connection of an ETM to the processor, and an Advanced High-performance Bus Access Port (AHB-AP) interface for debug accesses.

This section contains the following subsections:

- [2.3.1 Bus interfaces on page 2-25.](#)
- [2.3.2 ETM interface on page 2-26.](#)
- [2.3.3 AHB Trace Macrocell interface on page 2-27.](#)
- [2.3.4 Debug Port AHB-AP interface on page 2-27.](#)

2.3.1 Bus interfaces

The Cortex-M3 processor contains three external Advanced High-performance Bus (AHB)-Lite bus interfaces and one Advanced Peripheral Bus (APB) interface.

The processor matches the AMBA 3 specification except for maintaining control information during waited transfers. The AMBA 3 AHB-Lite Protocol states that when the slave is requesting wait states the master must not change the transfer type, except for the following cases:

- On an IDLE transfer, the master can change the transfer type from IDLE to NONSEQ.
- On a BUSY transfer with a fixed length burst, the master can change the transfer type from BUSY to SEQ.
- On a BUSY transfer with an undefined length burst, the master can change the transfer type from BUSY to any other transfer type.

The processor does not match this definition because it might change the access type from SEQ or NONSEQ to IDLE during a waited transfer. The processor might also change the address or other control information and therefore request an access to a new location. The original address that was retracted might not be requested again. This cancels the outstanding transfer that has not occurred because the previous access is wait-stated and awaiting completion. This is done so that the processor can have a lower interrupt latency and higher performance in wait-stated systems by retracting accesses that are no longer required.

To achieve complete compliance with the AMBA 3 specification you can implement the design with the AHB_CONST_CTRL parameter set to 1. This ensures that when transfers are issued during a wait-stated response they are never retracted or modified and the original transfer is honored. The consequence of setting this parameter is that the performance of the core might decrease for wait-stated systems as a result of the interrupt and branch latency increasing.

ICode memory interface

Instruction fetches from Code memory space `0x00000000` to `0x1FFFFFFF` are performed over the 32-bit AHB-Lite bus.

The Debugger cannot access this interface. All fetches are word-wide. The number of instructions fetched per word depends on the code running and the alignment of the code in memory.

DCode memory interface

Data and debug accesses to Code memory space `0x00000000` to `0x1FFFFFFF` are performed over the 32-bit AHB-Lite bus.

Core data accesses have a higher priority than debug accesses on this bus. This means that debug accesses are waited until core accesses have completed when there are simultaneous core and debug access to this bus.

Control logic in this interface converts unaligned data and debug accesses into two or three aligned accesses, depending on the size and alignment of the unaligned access. This stalls any subsequent data or debug access until the unaligned access has completed.

————— **Note** —————

ARM strongly recommends that any external arbitration between the ICode and DCode AHB bus interfaces ensures that DCode has a higher priority than ICode.

System interface

Instruction fetches and data and debug accesses to address ranges $0x20000000$ to $0xDFFFFFFF$ and $0xE0100000$ to $0xFFFFFFFF$ are performed over the 32-bit AHB-Lite bus.

For simultaneous accesses to the 32-bit AHB-Lite bus, the arbitration order in decreasing priority is:

- Data accesses.
- Instruction and vector fetches.
- Debug.

The system bus interface contains control logic to handle unaligned accesses, FPB remapped accesses, bit-band accesses, and pipelined instruction fetches.

Private Peripheral Bus (PPB)

Data and debug accesses to external PPB space $0xE0040000$ to $0xE00FFFFF$ are performed over the 32-bit Advanced Peripheral Bus (APB) bus.

The *Trace Port Interface Unit* (TPIU) and vendor specific peripherals are on the 32-bit Advanced Peripheral Bus (APB) bus.

Core data accesses have higher priority than debug accesses, so debug accesses are waited until core accesses have completed when there are simultaneous core and debug accesses to this bus. Only the address bits necessary to decode the External PPB space are supported on this interface.

The External PPB (EPPB) space, $0xE0040000$ up to $0xE0100000$, is intended for CoreSight-compatible debug and trace components, and has a number of irregular limitations which make it less useful for regular system peripherals. ARM recommends that system peripherals are placed in suitable Device type areas of the System bus address space, with use of an AHB2APB protocol converter for APB-based devices.

Limitations of the EPPB space are:

- It is accessible in privileged mode only.
- It is accessed in little-endian fashion irrespective of the data endianness setting of the processor.
- Accesses behave as Strongly Ordered.
- No bit-band function is available.
- Unaligned accesses have *Unpredictable* results.
- Only 32-bit data accesses are supported.
- It is accessible from the Debug Port and the local processor, but not from any other processor in the system.

2.3.2 ETM interface

The ETM interface enables simple connection of an ETM to the processor. It provides a channel for instruction trace to the ETM.

See the *ARM Embedded Trace Macrocell Architecture Specification*.

2.3.3 AHB Trace Macrocell interface

The AHB Trace Macrocell (HTM) interface enables a simple connection of the AHB trace macrocell to the processor, and provides a channel for the data trace to the HTM.

Your implementation must include this interface to use the HTM interface. You must set TRCENA to 1 in the *Debug Exception and Monitor Control Register (DEMCR)* before you enable the HTM port to supply trace data. See the *ARM®v7-M Architecture Reference Manual*.

2.3.4 Debug Port AHB-AP interface

The processor contains an Advanced High-performance Bus Access Port (AHB-AP) interface for debug accesses. An external Debug Port (DP) component accesses this interface.

The Cortex-M3 system supports three possible DP implementations:

- The *Serial Wire JTAG Debug Port (SWJ-DP)*. The SWJ-DP is a standard CoreSight debug port that combines JTAG-DP and *Serial Wire Debug Port (SW-DP)*.
- The SW-DP. This provides a two-pin interface to the AHB-AP port.
- No DP present. If no debug functionality is present within the processor, a DP is not required.

The two DP implementations provide different mechanisms for debug access to the processor. Your implementation must contain only one of these components.

————— **Note** —————

Your implementation might contain an alternative implementer-specific DP instead of SW-DP or SWJ-DP. See your implementer for details.

For more detailed information on the DP components, see the *CoreSight™ Components Technical Reference manual*.

The DP and AP together are referred to as the *Debug Access Port (DAP)*.

For more detailed information on the debug interface, see the *ARM® Debug Interface v5 Architecture Specification*.

Chapter 3

Programmers Model

This chapter describes the processor programmers model.

It contains the following sections:

- *3.1 About the programmers' model* on page 3-29.
- *3.2 Modes of operation and execution* on page 3-30.
- *3.3 Instruction set summary* on page 3-31.
- *3.4 Processor memory model* on page 3-37.
- *3.5 Write buffer* on page 3-40.
- *3.6 Exclusive monitor* on page 3-41.
- *3.7 Bit-banding* on page 3-42.
- *3.8 Processor core register summary* on page 3-44.
- *3.9 Exceptions* on page 3-46.

3.1 About the programmers' model

The Cortex-M3 programmers' model describes the processor's implementation-defined options.

For a complete description of the programmers' model, refer to the *ARM[®]v7-M Architecture Reference Manual*, which also contains the ARMv7-M Thumb instructions the model uses, and their cycle counts for the processor. In addition, other options of the programmers' model are described in the System Control, MPU, NVIC, FPU, Debug, DWT, ITM, and TPIU features topics.

3.2 Modes of operation and execution

The Cortex-M3 processor supports Thread and Handler operating modes, and may be run in Thumb or Debug operating states. In addition, the processor can limit or exclude access to some resources by executing code in privileged or unprivileged mode.

See the *ARM[®]v7-M Architecture Reference Manual* for more information about these modes of operation and execution.

Operating modes

The conditions which cause the processor to enter Thread or Handler mode are as follows:

- The processor enters Thread mode on Reset, or as a result of an exception return. Privileged and Unprivileged code can run in Thread mode.
- The processor enters Handler mode as a result of an exception. All code is privileged in Handler mode.

Operating states

The processor can operate in thumb or debug state:

- Thumb state. This is normal execution running 16-bit and 32-bit halfword aligned Thumb instructions.
- Debug State. This is the state when the processor is in halting debug.

Privileged access and user access

Handler mode is always privileged. Thread mode can be privileged or unprivileged.

3.3 Instruction set summary

The processor implements the ARMv7-M Thumb instruction set, and is binary compatible with the instruction sets and features implemented in other Cortex-M profile processors. Instructions can be paired in a way that achieves optimum reductions in timing.

This section contains the following subsections:

- [3.3.1 Processor instructions on page 3-31.](#)
- [3.3.2 Load/store timings on page 3-35.](#)
- [3.3.3 Binary compatibility with other Cortex processors on page 3-36.](#)

3.3.1 Processor instructions

The table summarizes the Cortex-M3 processor instruction set. For brevity, not all load and store addressing modes are shown in the table. The cycle counts provided are based on a system with zero wait states.

Within the assembler syntax, depending on the operation, the <op2> field can be replaced with one of the following options:

- A simple register specifier, for example *Rm*.
- An immediate shifted register, for example *Rm*, LSL #4.
- A register shifted register, for example *Rm*, LSL *Rs*.
- An immediate value, for example #0xE000E000.

For brevity, not all load and store addressing modes are shown. See the *ARMv7-M Architecture Reference Manual* for more information.

The following abbreviations are used in the Cycles column:

P

The number of cycles required for a pipeline refill. This ranges from 1 to 3 depending on the alignment and width of the target instruction, and whether the processor manages to speculate the address early.

B

The number of cycles required to perform the barrier operation. For DSB and DMB, the minimum number of cycles is zero. For ISB, the minimum number of cycles is equivalent to the number required for a pipeline refill.

N

The number of registers in the register list to be loaded or stored, including PC or LR.

W

The number of cycles spent waiting for an appropriate event.

Table 3-1 Cortex-M3 instruction set summary

Operation	Description	Assembler	Cycles
Move	Register	MOV <i>Rd</i> , <op2>	1
	16-bit immediate	MOVW <i>Rd</i> , #<imm>	1
	Immediate into top	MOVT <i>Rd</i> , #<imm>	1
	To PC	MOV PC, <i>Rm</i>	1 + P
Add	Add	ADD <i>Rd</i> , <i>Rn</i> , <op2>	1
	Add to PC	ADD PC, PC, <i>Rm</i>	1 + P
	Add with carry	ADC <i>Rd</i> , <i>Rn</i> , <op2>	1
	Form address	ADR <i>Rd</i> , <label>	1

Table 3-1 Cortex-M3 instruction set summary (continued)

Operation	Description	Assembler	Cycles
Subtract	Subtract	SUB Rd, Rn, <op2>	1
	Subtract with borrow	SBC Rd, Rn, <op2>	1
	Reverse	RSB Rd, Rn, <op2>	1
Multiply	Multiply	MUL Rd, Rn, Rm	1
	Multiply accumulate	MLA Rd, Rn, Rm	2
	Multiply subtract	MLS Rd, Rn, Rm	2
	Long signed	SMULL RdLo, RdHi, Rn, Rm	3 to 5
	Long unsigned	UMULL RdLo, RdHi, Rn, Rm	3 to 5
	Long signed accumulate	SMLAL RdLo, RdHi, Rn, Rm	4 to 7
	Long unsigned accumulate	UMLAL RdLo, RdHi, Rn, Rm	4 to 7
	Divide	Signed	SDIV Rd, Rn, Rm
Unsigned		UDIV Rd, Rn, Rm	2 to 12
Saturate	Signed	SSAT Rd, #<imm>, <op2>	1
	Unsigned	USAT Rd, #<imm>, <op2>	1
Compare	Compare	CMP Rn, <op2>	1
	Negative	CMN Rn, <op2>	1
Logical	AND	AND Rd, Rn, <op2>	1
	Exclusive OR	EOR Rd, Rn, <op2>	1
	OR	ORR Rd, Rn, <op2>	1
	OR NOT	ORN Rd, Rn, <op2>	1
	Bit clear	BIC Rd, Rn, <op2>	1
	Move NOT	MVN Rd, <op2>	1
	AND test	TST Rn, <op2>	1
	Exclusive OR test	TEQ Rn, <op1>	1
Shift	Logical shift left	LSL Rd, Rn, #<imm>	1
	Logical shift left	LSL Rd, Rn, Rs	1
	Logical shift right	LSR Rd, Rn, #<imm>	1
	Logical shift right	LSR Rd, Rn, Rs	1
	Arithmetic shift right	ASR Rd, Rn, #<imm>	1
	Arithmetic shift right	ASR Rd, Rn, Rs	1
Rotate	Rotate right	ROR Rd, Rn, #<imm>	1
	Rotate right	ROR Rd, Rn, Rs	1
	With extension	RRX Rd, Rn	1
Count	Leading zeroes	CLZ Rd, Rn	1

Table 3-1 Cortex-M3 instruction set summary (continued)

Operation	Description	Assembler	Cycles
Load	Word	LDR Rd, [Rn, <op2>]	2
	To PC	LDR PC, [Rn, <op2>]	2 + P
	Halfword	LDRH Rd, [Rn, <op2>]	2
	Byte	LDRB Rd, [Rn, <op2>]	2
	Signed halfword	LDRSH Rd, [Rn, <op2>]	2
	Signed byte	LDRSB Rd, [Rn, <op2>]	2
	User word	LDRT Rd, [Rn, #<imm>]	2
	User halfword	LDRHT Rd, [Rn, #<imm>]	2
	User byte	LDRBT Rd, [Rn, #<imm>]	2
	User signed halfword	LDRSHT Rd, [Rn, #<imm>]	2
	User signed byte	LDRSBT Rd, [Rn, #<imm>]	2
	PC relative	LDR Rd, [PC, #<imm>]	2
	Doubleword	LDRD Rd, Rd, [Rn, #<imm>]	1 + N
	Multiple	LDM Rn, {<reglist>}	1 + N
	Multiple including PC	LDM Rn, {<reglist>, PC}	1 + N + P
Store	Word	STR Rd, [Rn, <op2>]	2
	Halfword	STRH Rd, [Rn, <op2>]	2
	Byte	STRB Rd, [Rn, <op2>]	2
	Signed halfword	STRSH Rd, [Rn, <op2>]	2
	Signed byte	STRSB Rd, [Rn, <op2>]	2
	User word	STRT Rd, [Rn, #<imm>]	2
	User halfword	STRHT Rd, [Rn, #<imm>]	2
	User byte	STRBT Rd, [Rn, #<imm>]	2
	User signed halfword	STRSHT Rd, [Rn, #<imm>]	2
	User signed byte	STRSBT Rd, [Rn, #<imm>]	2
	Doubleword	STRD Rd, Rd, [Rn, #<imm>]	1 + N
	Multiple	STM Rn, {<reglist>}	1 + N
Push	Push	PUSH {<reglist>}	1 + N
	Push with link register	PUSH {<reglist>, LR}	1 + N
Pop	Pop	POP {<reglist>}	1 + N
	Pop and return	POP {<reglist>, PC}	1 + N + P

Table 3-1 Cortex-M3 instruction set summary (continued)

Operation	Description	Assembler	Cycles
Semaphore	Load exclusive	LDREX Rd, [Rn, #<imm>]	2
	Load exclusive half	LDREXH Rd, [Rn]	2
	Load exclusive byte	LDREXB Rd, [Rn]	2
	Store exclusive	STREX Rd, Rt, [Rn, #<imm>]	2
	Store exclusive half	STREXH Rd, Rt, [Rn]	2
	Store exclusive byte	STREXB Rd, Rt, [Rn]	2
	Clear exclusive monitor	CLREX	1
Branch	Conditional	B<cc> <label>	1 or 1 + P
	Unconditional	B <label>	1 + P
	With link	BL <label>	1 + P
	With exchange	BX Rm	1 + P
	With link and exchange	BLX Rm	1 + P
	Branch if zero	CBZ Rn, <label>	1 or 1 + P
	Branch if non-zero	CBNZ Rn, <label>	1 or 1 + P
	Byte table branch	TBB [Rn, Rm]	2 + P
	Halfword table branch	TBH [Rn, Rm, LSL#1]	2 + P
State change	Supervisor call	SVC #<imm>	-
	If-then-else	IT... <cond>	1
	Disable interrupts	CPSID <flags>	1 or 2
	Enable interrupts	CPSIE <flags>	1 or 2
	Read special register	MRS Rd, <specreg>	1 or 2
	Write special register	MSR <specreg>, Rn	1 or 2
	Breakpoint	BKPT #<imm>	-
Extend	Signed halfword to word	SXTH Rd, <op2>	1
	Signed byte to word	SXTB Rd, <op2>	1
	Unsigned halfword	UXTH Rd, <op2>	1
	Unsigned byte	UXTB Rd, <op2>	1
Bit field	Extract unsigned	UBFX Rd, Rn, #<imm>, #<imm>	1
	Extract signed	SBFX Rd, Rn, #<imm>, #<imm>	1
	Clear	BFC Rd, Rn, #<imm>, #<imm>	1
	Insert	BFI Rd, Rn, #<imm>, #<imm>	1

Table 3-1 Cortex-M3 instruction set summary (continued)

Operation	Description	Assembler	Cycles
Reverse	Bytes in word	REV Rd, Rm	1
	Bytes in both halfwords	REV16 Rd, Rm	1
	Signed bottom halfword	REVSH Rd, Rm	1
	Bits in word	RBIT Rd, Rm	1
Hint	Send event	SEV	1
	Wait for event	WFE	1 + W
	Wait for interrupt	WFI	1 + W
	No operation	NOP	1
Barriers	Instruction synchronization	ISB	1 + B
	Data memory	DMB	1 + B
	Data synchronization	DSB <flags>	1 + B

The following notes apply to the information in the table:

- UMULL, SMULL, UMLAL, and SMLAL instructions use early termination depending on the size of the source values. These are interruptible, that is abandoned and restarted, with worst case latency of one cycle.
- Neighboring load and store single instructions can pipeline their address and data phases. This enables these instructions to complete in a single execution cycle.
- For branch operations, conditional branch completes in a single cycle if the branch is not taken.
- An IT instruction can be folded onto a preceding 16-bit Thumb instruction, enabling execution in zero cycles.

3.3.2 Load/store timings

Instructions can be optimally paired to achieve more reductions in load and store timings.

The following information may help you to achieve further reductions in timing when pairing instructions:

- STR Rx, [Ry, #imm] is always one cycle. This is because the address generation is performed in the initial cycle, and the data store is performed at the same time as the next instruction is executing. If the store is to the write buffer, and the write buffer is full or not enabled, the next instruction is delayed until the store can complete. If the store is not to the write buffer, for example to the Code segment, and that transaction stalls, the impact on timing is only felt if another load or store operation is executed before completion.
- LDR PC, [any] is always a blocking operation. This means at least two cycles for the load, and three cycles for the pipeline reload. So this operation takes at least five cycles, or more if stalled on the load or the fetch.
- Any load or store that generates an address dependent on the result of a preceding data processing operation stalls the pipeline for an additional cycle while the register bank is updated. There is no forwarding path for this scenario.
- LDR Rx, [PC, #imm] might add a cycle because of contention with the fetch unit.
- TBB and TBH are also blocking operations. These are at least two cycles for the load, one cycle for the add, and three cycles for the pipeline reload. This means at least six cycles, or more if stalled on the load or the fetch.

- LDR [any] are pipelined when possible. This means that if the next instruction is an LDR or STR, and the destination of the first LDR is not used to compute the address for the next instruction, then one cycle is removed from the cost of the next instruction. So, an LDR might be followed by an STR, so that the STR writes out what the LDR loaded. More multiple LDRs can be pipelined together. Some optimized examples are:
 - LDR R0, [R1]; LDR R1, [R2] - normally three cycles total.
 - LDR R0, [R1, R2]; STR R0, [R3, #20] - normally three cycles total.
 - LDR R0, [R1, R2]; STR R1, [R3, R2] - normally three cycles total.
 - LDR R0, [R1, R5]; LDR R1, [R2]; LDR R2, [R3, #4] - normally four cycles total.
- Other instructions cannot be pipelined after STR with register offset. STR can only be pipelined when it follows an LDR, but nothing can be pipelined after the store. Even a stalled STR normally only takes two cycles, because of the write buffer.
- LDREX and STREX can be pipelined exactly as LDR. Because STREX is treated more like an LDR, it can be pipelined as explained for LDR. Equally LDREX is treated exactly as an LDR and so can be pipelined.
- LDRD and STRD cannot be pipelined with preceding or following instructions. However, the two words are pipelined together. So, this operation requires three cycles when not stalled.
- LDM and STM cannot be pipelined with preceding or following instructions. However, all elements after the first are pipelined together. So, a three element LDM takes 2+1+1 or 5 cycles when not stalled. Similarly, an eight element store takes nine cycles when not stalled. When interrupted, LDM and STM instructions continue from where they left off when returned to. The continue operation adds one or two cycles to the first element when started.
- Unaligned word or halfword loads or stores add penalty cycles. A byte aligned halfword load or store adds one extra cycle to perform the operation as two bytes. A halfword aligned word load or store adds one extra cycle to perform the operation as two halfwords. A byte-aligned word load or store adds two extra cycles to perform the operation as a byte, a halfword, and a byte. These numbers increase if the memory stalls. A STR or STRH cannot delay the processor because of the write buffer.

Example graphic

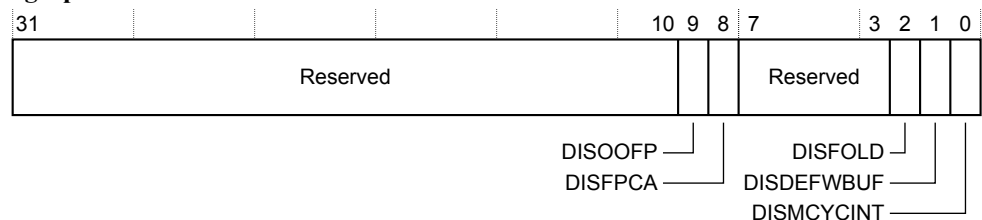

3.3.3 Binary compatibility with other Cortex processors

The processor implements a subset of the instruction set and features provided by the ARMv7-M architecture profile, and is binary compatible with the instruction sets and features implemented in other Cortex-M profile processors. You can move software, including system level software, from the Cortex-M3 processor to other Cortex-M profile processors.

To ensure a smooth transition, ARM recommends that code designed to operate on other Cortex-M profile processor architectures obey the following rules and configure the *Configuration and Control Register* (CCR) appropriately:

- Use word transfers only to access registers in the NVIC and *System Control Space* (SCS).
- Treat all unused SCS registers and register fields on the processor as Do-Not-Modify.
- Configure the following fields in the CCR:
 - STKALIGN bit to 1.
 - UNALIGN_TRP bit to 1.
 - Leave all other bits in the CCR register as their original value.

3.4 Processor memory model

The processor contains a bus matrix that arbitrates accesses to both the external memory system and to the internal System Control Space (SCS) and debug components, supports ARMv7 unaligned accesses, and performs all accesses as single, unaligned accesses.

Priority is always given to the processor to ensure that any debug accesses are as non-intrusive as possible. For a zero wait state system, all debug accesses to system memory, SCS, and debug resources are completely non-intrusive.

See the ARMv7-M Architecture Reference Manual for more information about the memory model.

The following figure shows the system address map.

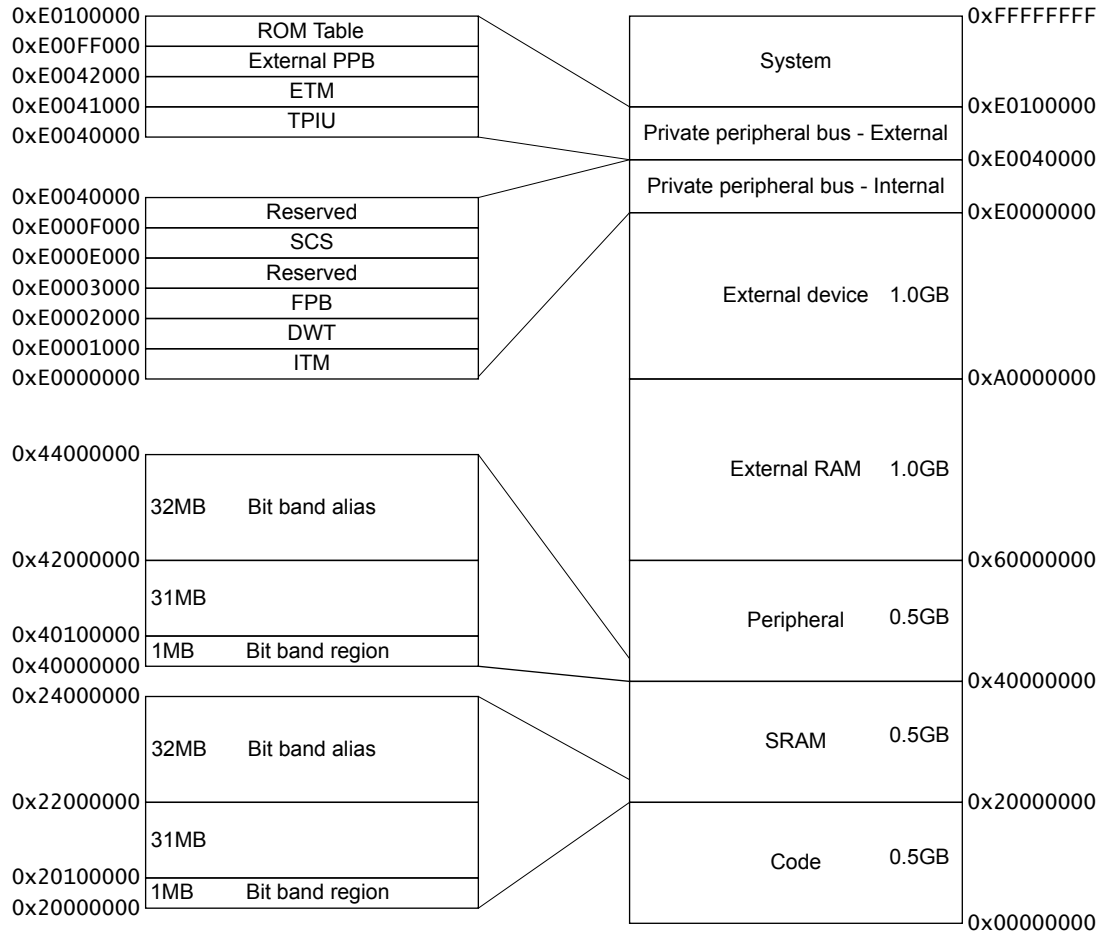

Figure 3-1 System address map

This section contains the following subsections:

- [3.4.1 Memory regions table on page 3-38.](#)
- [3.4.2 Private Peripheral Bus on page 3-38.](#)
- [3.4.3 Unaligned accesses that cross regions on page 3-38.](#)

3.4.1 Memory regions table

The table shows the processor interfaces that are addressed by the different memory map regions.

Table 3-2 Memory regions

Memory Map	Region
Code	Instruction fetches are performed over the ICode bus. Data accesses are performed over the DCode bus.
SRAM	Instruction fetches and data accesses are performed over the system bus.
SRAM bit-band	Alias region. Data accesses are aliases. Instruction accesses are not aliases.
Peripheral	Instruction fetches and data accesses are performed over the system bus.
Peripheral bit-band	Alias region. Data accesses are aliases. Instruction accesses are not aliases.
External RAM	Instruction fetches and data accesses are performed over the system bus.
External Device	Instruction fetches and data accesses are performed over the system bus.
Private Peripheral Bus	External and internal <i>Private Peripheral Bus</i> (PPB) interfaces. This memory region is <i>Execute Never</i> (XN), and so instruction fetches are prohibited. An MPU, if present, cannot change this.
System	System segment for vendor system peripherals. This memory region is XN, and so instruction fetches are prohibited. An MPU, if present, cannot change this.

3.4.2 Private Peripheral Bus

The Private Peripheral Bus (PPB) interface provides access to internal and external processor resources.

The internal *Private Peripheral Bus* (PPB) interface provides access to:

- The *Instrumentation Trace Macrocell* (ITM).
- The *Data Watchpoint and Trace* (DWT).
- The *Flashpatch and Breakpoint* (FPB).
- The *System Control Space* (SCS), including the *Memory Protection Unit* (MPU) and the *Nested Vectored Interrupt Controller* (NVIC).

The external PPB interface provides access to:

- The *Trace Point Interface Unit* (TPIU).
- The *Embedded Trace Macrocell* (ETM).
- The ROM table.
- Implementation-specific areas of the PPB memory map.

3.4.3 Unaligned accesses that cross regions

The Cortex-M3 processor supports ARMv7 unaligned accesses, and performs all accesses as single, unaligned accesses. They are converted into two or more aligned accesses by the DCode and System bus interfaces.

————— **Note** —————

All Cortex-M3 external accesses are aligned.

Unaligned support is only available for load/store singles (LDR, LDRH, STR, STRH). Load/store double already supports word aligned accesses, but does not permit other unaligned accesses, and generates a fault if this is attempted.

Unaligned accesses that cross memory map boundaries are architecturally UNPREDICTABLE. The processor behavior is boundary dependent, as follows:

- DCode accesses wrap within the region. For example, an unaligned halfword access to the last byte of Code space (0x1FFFFFFF) is converted by the DCode interface into a byte access to 0x1FFFFFFF followed by a byte access to 0x00000000.
- System accesses that cross into PPB space do not wrap within System space. For example, an unaligned halfword access to the last byte of System space (0xDFFFFFFF) is converted by the System interface into a byte access to 0xDFFFFFFF followed by a byte access to 0xE0000000. 0xE0000000 is not a valid address on the System bus.
- System accesses that cross into Code space do not wrap within System space. For example, an unaligned halfword access to the last byte of System space (0xFFFFFFFF) is converted by the System interface into a byte access to 0xFFFFFFFF followed by a byte access to 0x00000000. 0x00000000 is not a valid address on the System bus.
- Unaligned accesses are not supported to PPB space, and so there are no boundary crossing cases for PPB accesses.

Unaligned accesses that cross into the bit-band alias regions are also architecturally UNPREDICTABLE. The processor performs the access to the bit-band alias address, but this does not result in a bit-band operation. For example, an unaligned halfword access to 0x21FFFFFF is performed as a byte access to 0x21FFFFFF followed by a byte access to 0x22000000 (the first byte of the bit-band alias).

Unaligned loads that match against a literal comparator in the FPB are not remapped. FPB only remaps aligned addresses.

3.5 Write buffer

To prevent bus wait cycles from stalling the processor during data stores, buffered stores to the DCode and System buses go through a one-entry write buffer. If the write buffer is full, subsequent accesses to the bus stall until the write buffer has drained.

The write buffer is only used if the bus waits the data phase of the buffered store, otherwise the transaction completes on the bus.

DMB and DSB instructions wait for the write buffer to drain before completing. If an interrupt comes in while DMB or DSB is waiting for the write buffer to drain, the processor returns to the instruction following the DMB or DSB after the interrupt completes. This is because interrupt processing acts as a memory barrier operation.

3.6 Exclusive monitor

The Cortex-M3 processor implements a local exclusive monitor. The local monitor within the processor has been constructed so that it does not hold any physical address, but instead treats any access as matching the address of the previous LDREX. This means that the implemented exclusives reservation granule is the entire memory address range.

The Cortex-M3 processor does not support exclusive accesses to bit-band regions.

For more information about semaphores and the local exclusive monitor, see the *ARM[®]v7-M Architecture Reference Manual*.

3.7 Bit-banding

Bit-banding is an optional feature of the Cortex-M3 processor. Bit-banding maps a complete word of memory onto a single bit in the bit-band region. For example, writing to one of the alias words sets or clears the corresponding bit in the bit-band region.

This section contains the following subsections:

- [3.7.1 About bit-banding on page 3-42.](#)
- [3.7.2 Directly accessing an alias region on page 3-43.](#)
- [3.7.3 Directly accessing a bit-band region on page 3-43.](#)

3.7.1 About bit-banding

Bit-banding enables every individual bit in the bit-banding region to be directly accessible from a word-aligned address using a single LDR instruction. It also enables individual bits to be toggled without performing a read-modify-write sequence of instructions.

The processor memory map includes two bit-band regions. These occupy the lowest 1MB of the SRAM and Peripheral memory regions respectively. These bit-band regions map each word in an alias region of memory to a bit in a bit-band region of memory.

The System bus interface contains logic that controls bit-band accesses as follows:

- It remaps bit-band alias addresses to the bit-band region.
- For reads, it extracts the requested bit from the read byte, and returns this in the *Least Significant Bit* (LSB) of the read data returned to the core.
- For writes, it converts the write to an atomic read-modify-write operation.
- The processor does not stall during bit-band operations unless it attempts to access the System bus while the bit-band operation is being carried out.

The memory map has two 32MB alias regions that map to two 1MB bit-band regions:

- Accesses to the 32MB SRAM alias region map to the 1MB SRAM bit-band region.
- Accesses to the 32MB peripheral alias region map to the 1MB peripheral bit-band region.

A mapping formula shows how to reference each word in the alias region to a corresponding bit, or target bit, in the bit-band region. The mapping formula is:

$$\text{bit_word_offset} = (\text{byte_offset} \times 32) + (\text{bit_number} \times 4)$$

$$\text{bit_word_addr} = \text{bit_band_base} + \text{bit_word_offset}$$

where:

- `bit_word_offset` is the position of the target bit in the bit-band memory region.
- `bit_word_addr` is the address of the word in the alias memory region that maps to the targeted bit.
- `bit_band_base` is the starting address of the alias region.
- `byte_offset` is the number of the byte in the bit-band region that contains the targeted bit.
- `bit_number` is the bit position, 0 to 7, of the targeted bit.

The following figure shows examples of bit-band mapping between the SRAM bit-band alias region and the SRAM bit-band region:

- The alias word at `0x23FFFFFFE0` maps to bit [0] of the bit-band byte at `0x200FFFFF`: $0x23FFFFFFE0 = 0x22000000 + (0xFFFF * 32) + 0 * 4$.
- The alias word at `0x23FFFFFFC` maps to bit [7] of the bit-band byte at `0x200FFFFF`: $0x23FFFFFFC = 0x22000000 + (0xFFFF * 32) + 7 * 4$.
- The alias word at `0x22000000` maps to bit [0] of the bit-band byte at `0x20000000`: $0x22000000 = 0x22000000 + (0 * 32) + 0 * 4$.

- The alias word at `0x2200001C` maps to bit [7] of the bit-band byte at `0x20000000`: $0x2200001C = 0x22000000 + (0 \times 32) + 7 \times 4$.

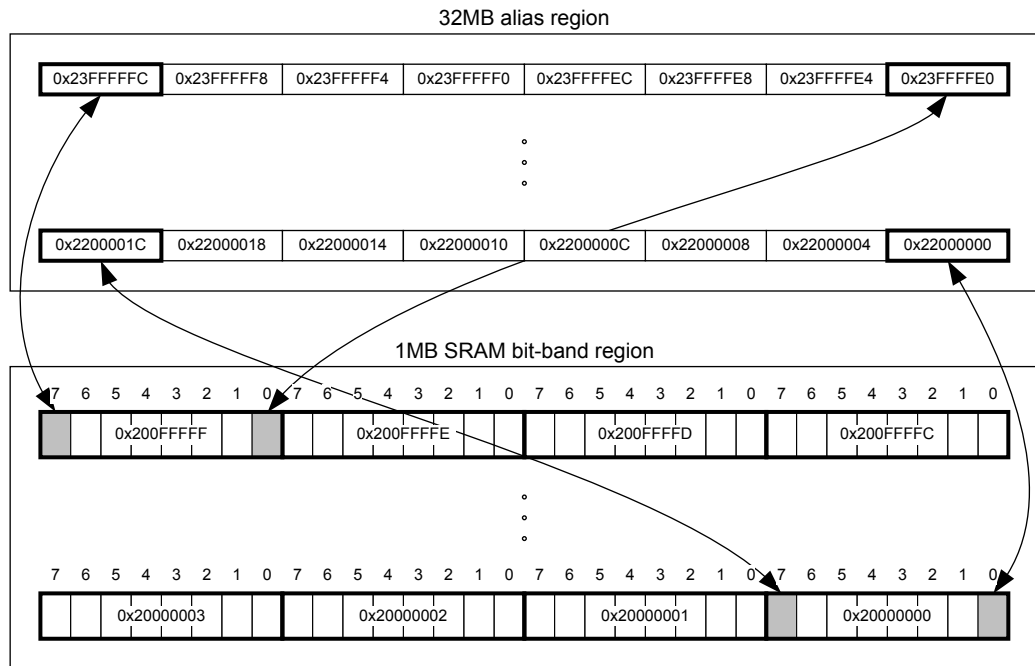

Figure 3-2 Bit-band mapping

3.7.2 Directly accessing an alias region

Writing to a word in the alias region has the same effect as a read-modify-write operation on the targeted bit in the bit-band region.

Bit [0] of the value written to a word in the alias region determines the value written to the targeted bit in the bit-band region. Writing a value with bit [0] set writes a 1 to the bit-band bit, and writing a value with bit [0] cleared writes a 0 to the bit-band bit.

Bits [31:1] of the alias word have no effect on the bit-band bit. Writing `0x01` has the same effect as writing `0xFF`. Writing `0x00` has the same effect as writing `0x0E`.

Reading a word in the alias region returns either `0x01` or `0x00`. A value of `0x01` indicates that the targeted bit in the bit-band region is set. A value of `0x00` indicates that the targeted bit is clear. Bits [31:1] are zero.

3.7.3 Directly accessing a bit-band region

You can directly access the bit-band region with normal reads and writes to that region.

3.8 Processor core register summary

The processor has 32-registers that includes 13 general-purpose registers and several special-purpose registers.

The processor has the following 32-bit registers:

- 13 general-purpose registers, R0-R12.
- *Stack Pointer* (SP), R13 alias of banked registers, SP_process and SP_main.
- *Link Register* (LR), R14.
- *Program Counter* (PC), R15.
- Special-purpose *Program Status Registers*, (xPSR).

The following figure shows the processor register set.

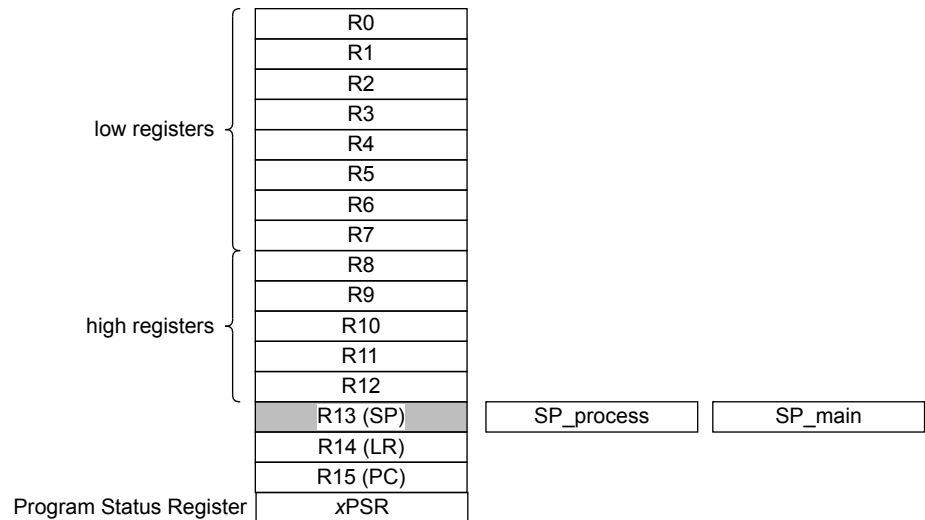

Figure 3-3 Processor register set

The general-purpose registers R0-R12 have no special architecturally-defined uses. Most instructions that can specify a general-purpose register can specify R0-R12.

Low registers

Registers R0-R7 are accessible by all instructions that specify a general-purpose register.

High registers

Registers R8-R12 are accessible by all 32-bit instructions that specify a general-purpose register.

Registers R8-R12 are not accessible by any 16-bit instructions.

Registers R13, R14, and R15 have the following special functions:

Stack pointer

Register R13 is used as the *Stack Pointer* (SP). Because the SP ignores writes to bits [1:0], it is autoaligned to a word, four-byte boundary.

Handler mode always uses SP_main, but you can configure Thread mode to use either SP_main or SP_process.

Link register

Register R14 is the subroutine *Link Register* (LR).

The LR receives the return address from PC when a *Branch and Link* (BL) or *Branch and Link with Exchange* (BLX) instruction is executed.

The LR is also used for exception return.

At all other times, you can treat R14 as a general-purpose register.

Program counter

Register R15 is the *Program Counter* (PC).

Bit [0] is always 0, so instructions are always aligned to word or halfword boundaries.

See the *ARMv7-M Architecture Reference Manual* for more information.

3.9 Exceptions

Exceptions are handled and prioritized by the processor and the NVIC. In addition to architecturally defined behavior, the processor implements advanced exception and interrupt handling that reduces interrupt latency and includes implementation defined behavior.

This section contains the following subsections:

- [3.9.1 Exception handling and prioritization on page 3-46.](#)
- [3.9.2 Interrupt latency on page 3-46.](#)
- [3.9.3 Base register update in LDM and STM operations on page 3-47.](#)

3.9.1 Exception handling and prioritization

The processor and the Nested Vectored Interrupt Controller (NVIC) prioritize and handle all exceptions.

When handling exceptions:

- All exceptions are handled in Handler mode.
- Processor state is automatically stored to the stack on an exception, and automatically restored from the stack at the end of the *Interrupt Service Routine* (ISR).
- The vector is fetched in parallel to the state saving, enabling efficient interrupt entry.

The processor supports tail-chaining that enables back-to-back interrupts without the overhead of state saving and restoration.

You configure the number of interrupts, and bits of interrupt priority, during implementation. Software can choose only to enable a subset of the configured number of interrupts, and can choose how many bits of the configured priorities to use.

Note

Vector table entries are compatible with interworking between ARM and Thumb instructions. This causes bit [0] of the vector value to load into the *Execution Program Status Register* (EPSR) T-bit on exception entry. All populated vectors in the vector table entries must have bit [0] set. Creating a table entry with bit [0] clear generates an INVSTATE fault on the first instruction of the handler corresponding to this vector.

3.9.2 Interrupt latency

The processor implements advanced exception and interrupt handling that reduces interrupt latency, and includes implementation defined behavior in addition to the architecturally defined behavior.

To reduce interrupt latency, the processor implements both interrupt late-arrival and interrupt tail-chaining mechanisms, as defined by the ARMv7-M architecture:

- There is a maximum of a twelve cycle latency from asserting the interrupt to execution of the first instruction of the ISR when the memory being accessed has no wait states being applied. The first instruction to be executed is fetched in parallel to the stack push.
- Returns from interrupts similarly take twelve cycles where the instruction being returned to is fetched in parallel to the stack pop.
- Tail chaining requires six cycles when using zero wait state memory. No stack pushes or pops are performed and only the instruction for the next ISR is fetched.

The processor exception model has the following implementation-defined behavior in addition to the architecturally defined behavior:

- Exceptions on stacking from HardFault to NMI lockup at NMI priority.
- Exceptions on unstacking from NMI to HardFault lockup at HardFault priority.

To minimize interrupt latency, the processor abandons any divide instruction to take any pending interrupt. On return from the interrupt handler, the processor restarts the divide instruction from the

beginning. The processor implements the Interruptible-continuable Instruction field. Load multiple (LDM) operations and store multiple (STM) operations are interruptible. The EPSR holds the information required to continue the load or store multiple from the point where the interrupt occurred.

This means that software must not use load-multiple or store-multiple instructions to access a device or access a memory region that is read-sensitive or sensitive to repeated writes. The software must not use these instructions in any case where repeated reads or writes might cause inconsistent results or unwanted side-effects.

For more information, see the *ARMv7-M Architecture Reference Manual*.

3.9.3 Base register update in LDM and STM operations

When the instruction specifies base register write-back, the base register changes to the updated address (an abort restores the original base value). When the base register is in the register list of an LDM, and is not the last register in the list, the base register changes to the loaded value.

An LDM or STM is restarted rather than continued if:

- The instruction faults.
- The instruction is inside an IT.

If an LDM has completed a base load, it is continued from before the base load.

Chapter 4

System Control

This chapter provides a summary of the system control registers whose implementation is specific to the Cortex-M3 processor.

Registers not described here are described in the *ARM[®]v7-M Architecture Reference Manual*.

It contains the following sections:

- [4.1 System control registers](#) on page 4-49.
- [4.2 Auxiliary Control Register, ACTLR](#) on page 4-51.
- [4.3 CPUID Base Register, CPUID](#) on page 4-52.
- [4.4 Auxiliary Fault Status Register, AFSR](#) on page 4-53.

4.1 System control registers

List of system control registers whose implementation is specific to the Cortex-M3 processor.

Registers not described in the table are described in the *ARMv7-M Architecture Reference Manual*.

Table 4-1 System control registers

Address	Name	Type	Reset	Description
0xE000E008	ACTLR	RW	0x00000000	Refer to the Auxiliary Control Register, ACTLR
0xE000E010	STCSR	RW	0x00000000	SysTick Control and Status Register
0xE000E014	STRVR	RW	Unknown	SysTick Reload Value Register
0xE000E018	STCVR	RW clear	Unknown	SysTick Current Value Register
0xE000E01C	STCR	RO	Implementation specific	SysTick Calibration Value Register
0xE000ED00	CPUID	RO	0x412FC231	Refer to the CPUID Base Register, CPUID
0xE000ED04	ICSR	RW or RO	0x00000000	Interrupt Control and State Register
0xE000ED08	VTOR	RW	0x00000000	Vector Table Offset Register
0xE000ED0C	AIRCR	RW	0x00000000	Application Interrupt and Reset Control Register. Bits [10:8] are reset to zero. The ENDIANNESS bit, bit [15], can reset to either state, depending on the implementation.
0xE000ED10	SCR	RW	0x00000000	System Control Register
0xE000ED14	CCR	RW	0x00000200	Configuration and Control Register.
0xE000ED18	SHPR1	RW	0x00000000	System Handler Priority Register 1
0xE000ED1C	SHPR2	RW	0x00000000	System Handler Priority Register 2
0xE000ED20	SHPR3	RW	0x00000000	System Handler Priority Register 3
0xE000ED24	SHCSR	RW	0x00000000	System Handler Control and State Register
0xE000ED28	CFSR	RW	0x00000000	Configurable Fault Status Registers
0xE000ED2C	HFSR	RW	0x00000000	HardFault Status Register
0xE000ED30	DFSR	RW	0x00000000	Debug Fault Status Register
0xE000ED34	MMFAR	RW	Unknown	MemManage Fault Address Register. BFAR and MMFAR are the same physical register. Because of this, the BFARVALID and MMFARVALID bits are mutually exclusive.
0xE000ED38	BFAR	RW	Unknown	BusFault Address Register. BFAR and MMFAR are the same physical register. Because of this, the BFARVALID and MMFARVALID bits are mutually exclusive.
0xE000ED3C	AFSR	RW	0x00000000	Refer to the Auxiliary Fault Status Register
0xE000ED40	ID_PFR0	RO	0x00000030	Processor Feature Register 0
0xE000ED44	ID_PFR1	RO	0x00000200	Processor Feature Register 1
0xE000ED48	ID_DFR0	RO	0x00100000	Debug Features Register 0. BFAR and MMFAR are the same physical register. Because of this, the BFARVALID and MMFARVALID bits are mutually exclusive.
0xE000ED4C	ID_AFR0	RO	0x00000000	Auxiliary Features Register 0

Table 4-1 System control registers (continued)

Address	Name	Type	Reset	Description
0xE000ED50	ID_MMFR0	RO	0x00100030	Memory Model Feature Register 0
0xE000ED54	ID_MMFR1	RO	0x00000000	Memory Model Feature Register 1
0xE000ED58	ID_MMFR2	RO	0x01000000	Memory Model Feature Register 2
0xE000ED5C	ID_MMFR3	RO	0x00000000	Memory Model Feature Register 3
0xE000ED60	ID_ISAR0	RO	0x01100110	Instruction Set Attributes Register 0
0xE000ED64	ID_ISAR1	RO	0x02111000	Instruction Set Attributes Register 1
0xE000ED68	ID_ISAR2	RO	0x21112231	Instruction Set Attributes Register 2
0xE000ED6C	ID_ISAR3	RO	0x01111110	Instruction Set Attributes Register 3
0xE000ED70	ID_ISAR4	RO	0x01310132	Instruction Set Attributes Register 4
0xE000ED88	CPACR	RW	0x00000000	Coprocessor Access Control Register
0xE000EF00	STIR	WO	0x00000000	Software Triggered Interrupt Register

4.2 Auxiliary Control Register, ACTLR

Characteristics and bit assignments of the ACTLR register.

Purpose

Disables certain aspects of functionality within the processor.

Usage Constraints

There are no usage constraints.

Configurations

This register is available in all processor configurations.

Attributes

See the System control registers table.

The following figure shows the ACTLR bit assignments.

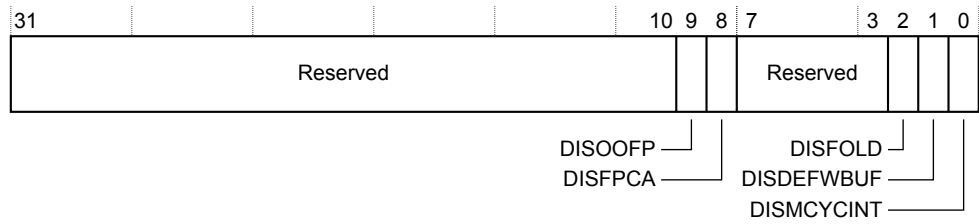

Figure 4-1 ACTLR bit assignments

The following table shows the ACTLR bit assignments.

Table 4-2 ACTLR bit assignments

Bits	Name	Function
[31:10]	-	Reserved.
[9]	DISOFP	Disables floating point instructions completing out of order with respect to integer instructions.
[8]	DISFPCA	SBZP.
[7:3]	-	Reserved
[2]	DISFOLD	Disables folding of IT instructions.
[1]	DISDEFWBUF	Disables write buffer use during default memory map accesses. This causes all bus faults to be precise, but decreases the performance of the processor because stores to memory must complete before the next instruction can be executed.
[0]	DISMCYCINT	Disables interruption of multi-cycle instructions. This increases the interrupt latency of the processor because load/store and multiply/divide operations complete before interrupt stacking occurs.

4.3 CPUID Base Register, CPUID

Characteristics and bit assignments of the CPUID register.

Purpose

Specifies:

- The ID number of the processor core.
- The version number of the processor core.
- The implementation details of the processor core.

Usage Constraints

There are no usage constraints.

Configurations

This register is available in all processor configurations.

Attributes

Described in the System control registers table.

The following figure shows the CPUID bit assignments.

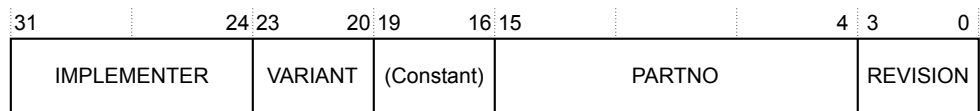

Figure 4-2 CPUID bit assignments

The following table shows the CPUID bit assignments.

Table 4-3 CPUID bit assignments

Bits	NAME	Function
[31:24]	IMPLEMENTER	Indicates implementer: 0x41 = ARM
[23:20]	VARIANT	Indicates processor revision: 0x0 = Revision 0
[19:16]	(Constant)	Reads as 0xF
[15:4]	PARTNO	Indicates part number: 0xC24 = Cortex-M3
[3:0]	REVISION	Indicates patch release: 0x1 = Patch 1.

4.4 Auxiliary Fault Status Register, AFSR

Characteristics and bit assignments of the AFSR register.

Purpose

Specifies additional system fault information to software.

Usage Constraints

The AFSR flags map directly onto the AUXFAULT inputs of the processor, and a single-cycle high level on an external pin causes the corresponding AFSR bit to become latched as one. The bit can only be cleared by writing a one to the corresponding AFSR bit.

When an AFSR bit is written or latched as one, an exception does not occur. To make use of AUXFAULT input signals, software must poll the AFSR.

Configurations

This register is available in all processor configurations.

Attributes

See the System control registers table.

The following figure shows the AFSR bit assignments.

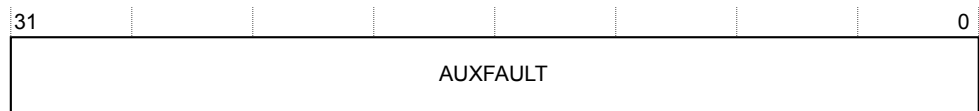

Figure 4-3 AFSR bit assignments

The following table shows the AFSR bit assignments.

Table 4-4 AFSR bit assignments

Bits	Name	Function
[31:0]	AUXFAULT	Latched version of the AUXFAULT inputs.

Chapter 5

Memory Protection Unit

This chapter describes the processor Memory Protection Unit (MPU).

It contains the following sections:

- [5.1 About the MPU on page 5-55.](#)
- [5.2 MPU functional description on page 5-56.](#)
- [5.3 MPU programmers model table on page 5-57.](#)

5.1 About the MPU

The MPU enforces privilege rules, separates processes, and enforces access rules to memory. The MPU is an optional component and supports the standard ARMv7 Protected Memory System Architecture model.

The MPU provides full support for:

- Protection regions.
- Overlapping protection regions, with ascending region priority:
 - 7 = highest priority.
 - 0 = lowest priority.
- Access permissions.
- Exporting memory attributes to the system.

MPU mismatches and permission violations invoke the programmable-priority MemManage fault handler. See the *ARM[®]v7-M Architecture Reference Manual* for more information.

You can use the MPU to:

- Enforce privilege rules.
- Separate processes.
- Enforce access rules.

5.2 MPU functional description

The access permission bits, TEX, C, B, AP, and XN, of the Region Access Control Register control access to the corresponding memory region. If an access is made to an area of memory without the required permissions, a permission fault is raised.

For more information, see the *ARM[®]v7-M Architecture Reference Manual*.

5.3 MPU programmers model table

Table of MPU registers, with address, name, type, reset, and description information.

These registers are described in the *ARMv7-M Architecture Reference Manual*.

Table 5-1 MPU registers

Address	Name	Type	Reset	Description
0xE000ED90	MPU_TYPE	RO	0x00000800	MPU Type Register If the MPU is not present in the implementation this register reads as zero.
0xE000ED94	MPU_CTRL	RW	0x00000000	MPU Control Register
0xE000ED98	MPU_RNR	RW	0x00000000	MPU Region Number Register
0xE000ED9C	MPU_RBAR	RW	0x00000000	MPU Region Base Address Register
0xE000EDA0	MPU_RASR	RW	0x00000000	MPU Region Attribute and Size Register
0xE000EDA4	MPU_RBAR_A1		0x00000000	MPU alias registers
0xE000EDA8	MPU_RASR_A1		0x00000000	
0xE000EDAC	MPU_RBAR_A2		0x00000000	
0xE000EDB0	MPU_RASR_A2		0x00000000	
0xE000EDB4	MPU_RBAR_A3		0x00000000	
0xE000EDB8	MPU_RASR_A3		0x00000000	

Chapter 6

Nested Vectored Interrupt Controller

This chapter describes the *Nested Vectored Interrupt Controller* (NVIC). The NVIC provides configurable interrupt handling abilities to the processor, facilitates low- latency exception and interrupt handling, and controls power management.

It contains the following sections:

- [6.1 NVIC functional description](#) on page 6-59.
- [6.2 NVIC programmers' model](#) on page 6-60.

6.1 NVIC functional description

The NVIC supports up to 240 interrupts, each with up to 256 levels of priority that can be changed dynamically. The processor and NVIC can be put into a very low-power sleep mode, leaving the Wake Up Controller (WIC) to identify and prioritize interrupts. Also, the processor supports both level and pulse interrupts.

This section contains the following subsections:

- [6.1.1 NVIC interrupts on page 6-59.](#)
- [6.1.2 Low power modes on page 6-59.](#)
- [6.1.3 Level versus pulse interrupts on page 6-59.](#)

6.1.1 NVIC interrupts

The NVIC supports up to 240 interrupts, each with up to 256 levels of priority. You can change the priority of an interrupt dynamically.

The NVIC and the processor core interface are closely coupled, to enable low latency interrupt processing and efficient processing of late arriving interrupts. The NVIC maintains knowledge of the stacked, or nested, interrupts to enable tail-chaining of interrupts. You can only fully access the NVIC from privileged mode, but you can cause interrupts to enter a pending state in user mode if you enable the Configuration and Control Register. Any other user mode access causes a bus fault.

You can access all NVIC registers using byte, halfword, and word accesses unless otherwise stated. NVIC registers are located within the SCS.

All NVIC registers and system debug registers are little-endian regardless of the endianness state of the processor.

6.1.2 Low power modes

Your processor implementation can include a Wake-up Interrupt Controller (WIC). This enables the processor and NVIC to be put into a very low-power sleep mode leaving the WIC to identify and prioritize interrupts.

The processor fully implements the *Wait For Interrupt* (WFI), *Wait For Event* (WFE) and the *Send Event* (SEV) instructions. In addition, the processor also supports the use of SLEEPONEXIT, that causes the processor core to enter sleep mode when it returns from an exception handler to Thread mode. See the *ARM[®]v7-M Architecture Reference Manual* for more information.

6.1.3 Level versus pulse interrupts

The processor supports both level and pulse interrupts. A level interrupt is held asserted until it is cleared by the ISR accessing the device. A pulse interrupt is a variant of an edge model.

You must ensure that the pulse is sampled on the rising edge of the Cortex-M3 clock, **FCLK**, instead of being asynchronous.

For level interrupts, if the signal is not deasserted before the return from the interrupt routine, the interrupt again enters the pending state and re-activates. This is particularly useful for FIFO and buffer-based devices because it ensures that they drain either by a single ISR or by repeated invocations, with no extra work. This means that the device holds the signal in assert until the device is empty.

A pulse interrupt can be reasserted during the ISR so that the interrupt can be in the pending state and active at the same time. If another pulse arrives while the interrupt is still pending, the interrupt remains pending and the ISR runs only once.

Pulse interrupts are mostly used for external signals and for rate or repeat signals.

6.2 NVIC programmers' model

Summary of the NVIC registers whose implementation is specific to the Cortex-M3 processor.

Registers not described here are described in the *ARM®v7M Architecture Reference Manual*.

This section contains the following subsections:

- [6.2.1 Table of NVIC registers on page 6-60.](#)
- [6.2.2 Interrupt Controller Type Register, ICTR on page 6-60.](#)

6.2.1 Table of NVIC registers

Table showing the NVIC registers, with address, name, type, reset and description information for each register.

Table 6-1 NVIC registers

Address	Name	Type	Reset	Description
0xE000E004	ICTR	RO	-	Interrupt Controller Type Register, ICTR
0xE000E100 - 0xE000E11C	NVIC_ISER0 - NVIC_ISER7	RW	0x00000000	Interrupt Set-Enable Registers
0xE000E180 - 0xE000E19C	NVIC_ICER0 - NVIC_ICER7	RW	0x00000000	Interrupt Clear-Enable Registers
0xE000E200 - 0xE000E21C	NVIC_ISPR0 - NVIC_ISPR7	RW	0x00000000	Interrupt Set-Pending Registers
0xE000E280 - 0xE000E29C	NVIC_ICPR0 - NVIC_ICPR7	RW	0x00000000	Interrupt Clear-Pending Registers
0xE000E300 - 0xE000E31C	NVIC_IABR0 - NVIC_IABR7	RO	0x00000000	Interrupt Active Bit Register
0xE000E400 - 0xE000E4EC	NVIC_IPR0 - NVIC_IPR59	RW	0x00000000	Interrupt Priority Register

6.2.2 Interrupt Controller Type Register, ICTR

Characteristics and bit assignments of the ICTR register.

Purpose

Shows the number of interrupt lines that the NVIC supports.

Usage Constraints

There are no usage constraints.

Configurations

This register is available in all processor configurations.

Attributes

See the register summary information.

The following figure shows the ICTR bit assignments.

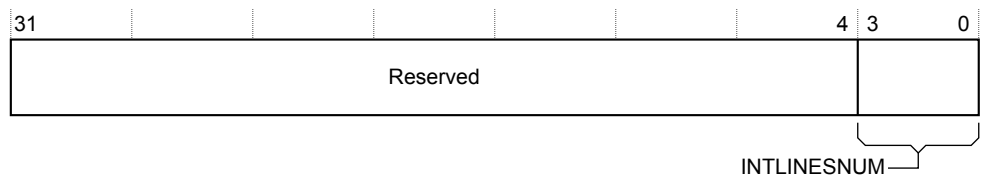

Figure 6-1 ICTR bit assignments

The following table shows the ICTR bit assignments.

Table 6-2 ICTR bit assignments

Bits	Name	Function	Notes
[31:4]	-	Reserved.	
[3:0]	INTLINESNUM	Total number of interrupt lines in groups of 32: 0b0000 = 0...32 0b0001 = 33...64 0b0010 = 65...96 0b0011 = 97...128 0b0100 = 129...160 0b0101 = 161...192 0b0110 = 193...224 0b0111 = 225...256	The processor supports a maximum of 240 external interrupts.

Chapter 7

Debug

This chapter describes how to debug and test software running on the processor.

It contains the following sections:

- [7.1 Debug configuration](#) on page 7-63.
- [7.2 AHB-AP debug access port](#) on page 7-67.
- [7.3 Flash Patch and Breakpoint Unit \(FPB\)](#) on page 7-70.

7.1 Debug configuration

The processor implementation determines the debug configuration, including whether debug is implemented. Basic debug functionality includes processor halt, single-step, processor core register access, Vector Catch, unlimited software breakpoints, and full system memory access.

If the processor does not implement debug, no ROM table is present and the halt, breakpoint, and watchpoint functionality is not present.

The debug option might include:

- A breakpoint unit supporting two literal comparators and six instruction comparators, or only two instruction comparators.
- A watchpoint unit supporting one or four watchpoints.

See the *ARM[®]v7-M Architectural Reference Manual* for more information.

This section contains the following subsections:

- [7.1.1 CoreSight™ discovery on page 7-63.](#)
- [7.1.2 Debugger actions for identifying the processor on page 7-64.](#)
- [7.1.3 ROM table identification and entries on page 7-64.](#)
- [7.1.4 ROM table components on page 7-65.](#)
- [7.1.5 System Control Space on page 7-66.](#)
- [7.1.6 Debug register summary on page 7-66.](#)

7.1.1 CoreSight™ discovery

For processors that implement debug, ARM recommends that a debugger identify and connect to the debug components using the CoreSight debug infrastructure.

The following figure shows the recommended flow that a debugger can follow to discover the components in the CoreSight debug infrastructure. In this case a debugger reads the peripheral and component ID registers for each CoreSight component in the CoreSight system.

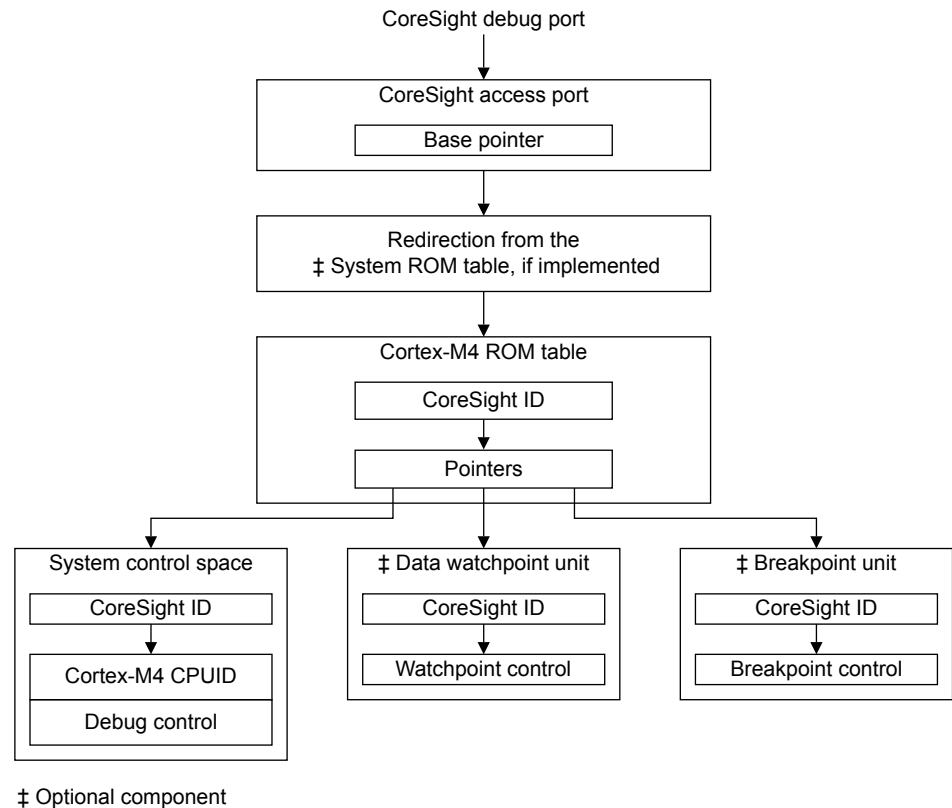

Figure 7-1 CoreSight discovery

7.1.2 Debugger actions for identifying the processor

When a debugger identifies the SCS from its CoreSight identification, it can identify the processor and its revision number from the CPUID register in the SCS at address `0xE00ED00`.

To identify the Cortex-M3 processor within the CoreSight system, ARM recommends that a debugger perform the following actions:

1. Locate and identify the Cortex-M3 ROM table using its CoreSight identification. See the Cortex-M3 ROM table identification values table.
2. Follow the pointers in that Cortex-M3 ROM table:
 - a. *System Control Space* (SCS).
 - b. *Breakpoint unit* (BPU).
 - c. *Data Watchpoint and Trace unit* (DWT).

See the Cortex-M3 ROM table components table.

A debugger cannot rely on the Cortex-M3 ROM table being the first ROM table encountered. One or more system ROM tables are required between the access port and the Cortex-M3 ROM table if other CoreSight components are in the system. If a system ROM table is present, this can include a unique identifier for the implementation.

7.1.3 ROM table identification and entries

The table shows the ROM table identification registers and values for debugger detection. The values allow debuggers to identify the processor and its debug capabilities. The values for the Peripheral ID registers identify this as a generic ROM table for the Cortex-M3 processor. Your implementation might use these registers to identify the manufacturer and part number for the device.

The Component ID registers identify this as a CoreSight ROM table.

Note

The Cortex-M3 ROM table only supports word size transactions.

See the *ARM[®]v7-M Architectural Reference Manual* and the *ARM[®] CoreSight[™] Components Technical Reference Manual* for more information about the ROM table ID and component registers, and their addresses and access types.

Table 7-1 Cortex-M3 ROM table identification values

Address	Register	Value	Description
0xE00FFFD0	Peripheral ID4	0x00000004	<i>Component and Peripheral ID register formats in the ARM[®]v7-M Architectural Reference Manual</i>
0xE00FFFD4	Peripheral ID5	0x00000000	
0xE00FFFD8	Peripheral ID6	0x00000000	
0xE00FFDC	Peripheral ID7	0x00000000	
0xE00FFE0	Peripheral ID0	0x000000C4	
0xE00FFE4	Peripheral ID1	0x000000B4	
0xE00FFE8	Peripheral ID2	0x0000000B	
0xE00FFEC	Peripheral ID3	0x00000000	
0xE00FFF0	Component ID0	0x0000000D	
0xE00FFF4	Component ID1	0x00000010	
0xE00FFF8	Component ID2	0x00000005	
0xE00FFFC	Component ID3	0x000000B1	

7.1.4 ROM table components

The table shows the CoreSight components that the Cortex-M3 ROM table points to. The values depend on the implemented debug configuration. The ROM table entries point to the debug components of the processor. The offset for each entry is the offset of that component from the ROM table base address, E00FF000.

Table 7-2 Cortex-M3 ROM table components

Address	Component	Value	Description
0xE00FF000	SCS	0xFFF0F003	Refer to information for the System Control Space.
0xE00FF004	DWT	0xFFF02003	Refer to information for the Data Watchpoint programmer's model. Value reads as 0xFFF02002 if no watchpoints are implemented.
0xE00FF008	FPB	0xFFF03003	Refer to information for the Flash Patch and Breakpoint Unit (FPB). Value reads as 0xFFF03002 if no breakpoints are implemented.
0xE00FF00C	ITM	0xFFF01003	Refer to information for the Instrumentation Trace Macrocell Unit. Value reads as 0xFFF01002 if no ITM is implemented.
0xE00FF010	TPIU	0xFFF41003	Refer to information for the Trace Port Interface Unit. Value reads as 0xFFF41002 if no TPIU is implemented.

Table 7-2 Cortex-M3 ROM table components (continued)

Address	Component	Value	Description
0xE00FF014	ETM	0xFFFF4203	See the <i>ETM-M4 Technical Reference Manual</i> . Value reads as 0xFFFF4202 if no ETM is implemented.
0xE00FF018	End marker	0x00000000	See <i>DAP accessible ROM table</i> in the <i>ARM®v7-M Architectural Reference Manual</i> .
0xE00FFFC	SYSTEM ACCESS	0x00000001	

7.1.5 System Control Space

If debug is implemented, the processor provides debug through registers in the SCS.

Final debugger identification of the Cortex-M3 processor is through the CPUID register in the SCS.

Table 7-3 SCS identification values

Address	Register	Value	Description
0xE00EFD0	Peripheral ID4	0x00000004	<i>Component and Peripheral ID register formats</i> in the <i>ARMv7-M Architectural Reference Manual</i> .
0xE00EFE0	Peripheral ID0	0x00000000	
0xE00EFE4	Peripheral ID1	0x000000B0	
0xE00EFE8	Peripheral ID2	0x0000000B	
0xE00EFEC	Peripheral ID3	0x00000000	
0xE00EFF0	Component ID0	0x0000000D	
0xE00EFF4	Component ID1	0x000000E0	
0xE00EFF8	Component ID2	0x00000005	
0xE00EFFF	Component ID3	0x000000B1	

See the *ARMv7-M Architectural Reference Manual* and the *ARM CoreSight™ Components Technical Reference Manual* for more information about the SCS CoreSight identification registers, and their addresses and access types.

7.1.6 Debug register summary

Summary of the debug registers. Each register is 32 bits wide. Core debug is an optional component. If core debug is removed then halt mode debugging is not supported, and there is no halt, stepping, or register transfer functionality. Debug monitor mode is still supported.

Debug registers are described in the *ARM®v7-M Architectural Reference Manual*.

Table 7-4 Debug registers

Address	Name	Type	Reset	Description
0xE00ED30	DFSR	RW	0x00000000	Debug Fault Status Register Power-on reset only.
0xE00EDF0	DHCSR	RW	0x00000000	Debug Halting Control and Status Register
0xE00EDF4	DCRSR	WO	-	Debug Core Register Selector Register
0xE00EDF8	DCRDR	RW	-	Debug Core Register Data Register
0xE00EDFC	DEMCR	RW	0x00000000	Debug Exception and Monitor Control Register

7.2 AHB-AP debug access port

The AHB-AP is an optional debug access port into the processor system that provides access to all memory and registers in the system, including processor registers through the SCS. System access is independent of the processor status. Either SW-DP or SWJ-DP is used to access the AHB-AP.

The AHB-AP is a *Memory Access Port (MEM-AP)* as defined in the *ARM® Debug Interface v5 Architecture Specification*.

The AHB-AP is a master into the Bus Matrix. Transactions are made using the AHB-AP programmers' model, which generates AHB-Lite transactions into the Bus Matrix.

This section contains the following subsections:

- [7.2.1 AHB-AP transaction types on page 7-67.](#)
- [7.2.2 AHB-AP programmers model on page 7-67.](#)

7.2.1 AHB-AP transaction types

The AHB-AP can perform unaligned and bit-band transactions.

The Bus Matrix handles AHB-AP transactions. The AHB-AP does not perform back-to-back transactions on the bus, and so all transactions are non-sequential. The AHB-AP transactions are not subject to MPU lookups. AHB-AP transactions bypass the FPB, and so the FPB cannot remap AHB-AP transactions.

AHB-AP transactions are little-endian.

7.2.2 AHB-AP programmers model

The programmers model lists all AHB-AP registers and describes those registers whose implementation is specific to the processor.

Other registers are described in the *CoreSight™ Components Technical Reference Manual*.

AHB-AP registers

Table showing the AHB-AP registers. Any register not specified in this table reads as zero. The offset given in this table is relative to the location of the AHB-AP in the DAP memory space. This space is only visible from the access port. It is not part of the processor memory map.

Table 7-5 AHB-AP register summary

Offset	Name	Type	Reset	Description
0x00	CSW	RW	See register	AHB-AP Control and Status Word Register, CSW
0x04	TAR	RW	-	AHB-AP Transfer Address Register
0x0C	DRW	RW	-	AHB-AP Data Read/Write Register
0x10	BD0	RW	-	AHB-AP Banked Data Register0
0x14	BD1	RW	-	AHB-AP Banked Data Register1
0x18	BD2	RW	-	AHB-AP Banked Data Register2
0x1C	BD3	RW	-	AHB-AP Banked Data Register3
0xF8	DBGDRAR	RO	0xE00FF003	AHB-AP ROM Address Register
0xFC	IDR	RO	0x24770011	AHB-AP Identification Register

AHB-AP Control and Status Word Register, CSW

Characteristics and bit assignments of the CSW register.

Purpose

Configures and controls transfers through the AHB interface.

Usage constraints

There are no usage constraints.

Configurations

This register is available in all processor configurations.

Attributes

Refer to the AHB-AP register summary table.

The following figure shows the CSW bit assignments.

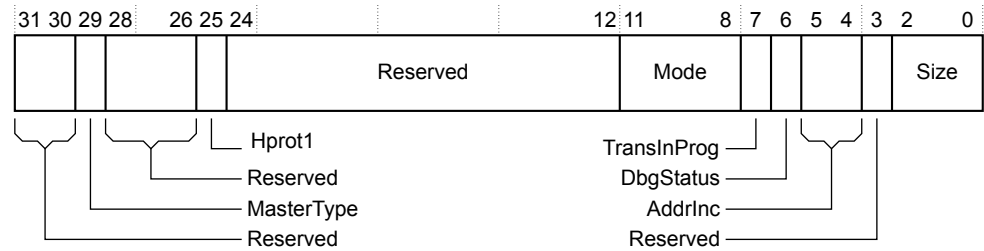

Figure 7-2 CSW bit assignments

The following table shows the CSW bit assignments.

Table 7-6 CSW bit assignments

Bits	Name	Function
[31:30]	-	Reserved. Read as 0b00 .
[29]	MasterType	0 = core. 1 = debug. This bit must not be changed if a transaction is outstanding. A debugger must first check bit [7], TransInProg. Reset value = 0b1 . An implementation can configure this bit to be read only with a value of 1. In that case, transactions are always indicated as debug. Note: When clear, this bit prevents the debugger from setting the C_DEBUGEN bit in the Debug Halting Control and Status Register, and so prevents the debugger from being able to halt the processor.
[28:26]	-	Reserved, 0b000 .
[25]	Hprot1	User and Privilege control - HPROT[1]. Reset value = 0b1 .
[24]	-	Reserved, 0b1 .
[23:12]	-	Reserved, 0x000 .
[11:8]	Mode	Mode of operation bits: 0b0000 = normal download and upload mode 0b0001-0b1111 are reserved. Reset value = 0b0000 .
[7]	TransInProg	Transfer in progress. This field indicates if a transfer is in progress on the AHB master port.

Table 7-6 CSW bit assignments (continued)

Bits	Name	Function
[6]	DbgStatus	<p>Indicates the status of the DAPEN port.</p> <p>0 = AHB transfers not permitted.</p> <p>1 = AHB transfers permitted.</p>
[5:4]	AddrInc	<p>Auto address increment and pack mode on Read or Write data access. Only increments if the current transaction completes with no error.</p> <p>Auto address incrementing and packed transfers are not performed on access to Banked Data registers 0x10 - 0x1C. The status of these bits is ignored in these cases.</p> <p>Increments and wraps within a 4KB address boundary, for example from 0x1000 to 0x1FFC. If the start is at 0x14A0, the counter increments to 0x1FFC, wraps to 0x1000, then continues incrementing to 0x149C.</p> <p>0b00 = auto increment off.</p> <p>0b01 = increment single. Single transfer from corresponding byte lane.</p> <p>0b10 = increment packed. See the definition of packed transfers in the <i>ARM® Debug Interface v5 Architecture Specification</i></p> <p>0b11 = reserved. No transfer.</p> <p>Size of address increment is defined by the Size field [2:0].</p> <p>Reset value: 0b00.</p>
[3]	-	Reserved.
[2:0]	Size	<p>Size of access field:</p> <p>0b000 = 8 bits</p> <p>0b001 = 16 bits</p> <p>0b010 = 32 bits</p> <p>0b011-111 are reserved.</p> <p>Reset value: 0b000.</p>

7.3 Flash Patch and Breakpoint Unit (FPB)

The Cortex-M3 processor contains a Flash Patch and Breakpoint (FPB) unit that implements hardware breakpoints, and patches code and data from Code space to System space.

This section contains the following subsections:

- [7.3.1 FPB full and reduced units on page 7-70.](#)
- [7.3.2 FPB functional description on page 7-70.](#)
- [7.3.3 FPB programmers' model on page 7-71.](#)

7.3.1 FPB full and reduced units

The FPB is available as a full unit or as a reduced unit.

A full FPB unit contains:

- Two literal comparators for matching against literal loads from Code space, and remapping to a corresponding area in System space.
- Six instruction comparators for matching against instruction fetches from Code space, and remapping to a corresponding area in System space. Alternatively, you can configure the comparators individually to return a *Breakpoint Instruction* (BKPT) to the processor core on a match, to provide hardware breakpoint capability.

A reduced FPB unit contains:

- Two instruction comparators. You can configure each comparator individually to return a Breakpoint Instruction to the processor on a match, to provide hardware breakpoint capability.

7.3.2 FPB functional description

The FPB contains both a global enable and individual enables for the eight comparators.

If the comparison for an entry matches, the address is either:

- Remapped to the address set in the remap register plus an offset corresponding to the comparator that matched.
- Remapped to a BKPT instruction if that feature is enabled.

The comparison happens dynamically, but the result of the comparison occurs too late to stop the original instruction fetch or literal load taking place from the Code space. The processor ignores this transaction however, and only the remapped transaction is used.

If an MPU is present, the MPU lookups are performed for the original address, not the remapped address.

You can remove the FPB if no debug is required, or you can reduce the number of breakpoints it supports to two. If the FPB supports only two breakpoints then only comparators 0 and 1 are used, and the FPB does not support flash patching.

Note

- Unaligned literal accesses are not remapped. The original access to the DCode bus takes place in this case.
 - Load exclusive accesses can be remapped. However, it is UNPREDICTABLE whether they are performed as exclusive accesses or not.
 - Setting the flash patch remap location to a bit-band alias is not supported and results in UNPREDICTABLE behavior.
-

7.3.3 FPB programmers' model

Table showing the FPB registers. Depending on the implementation of your processor, some of the registers might not be present. Any register that is configured as not present reads as zero.

Table 7-7 FPB register summary

Address	Name	Type	Reset	Description	Notes
0xE0002000	FP_CTRL	RW	0x260	FlashPatch Control Register	
0xE0002004	FP_REMAP	RW	-	FlashPatch Remap Register	
0xE0002008	FP_COMP0	RW	b0	FlashPatch Comparator Register0	For FP_COMP0 to FP_COMP7, bit 0 is reset to 0. Other bits in these registers are not reset.
0xE000200C	FP_COMP1	RW	b0	FlashPatch Comparator Register1	
0xE0002010	FP_COMP2	RW	b0	FlashPatch Comparator Register2	
0xE0002014	FP_COMP3	RW	b0	FlashPatch Comparator Register3	
0xE0002018	FP_COMP4	RW	b0	FlashPatch Comparator Register4	
0xE000201C	FP_COMP5	RW	b0	FlashPatch Comparator Register5	
0xE0002020	FP_COMP6	RW	b0	FlashPatch Comparator Register6	
0xE0002024	FP_COMP7	RW	b0	FlashPatch Comparator Register7	
0xE0002FD0	PID4	RO	0x04	Peripheral identification registers	
0xE0002FD4	PID5	RO	0x00		
0xE0002FD8	PID6	RO	0x00		
0xE0002FDC	PID7	RO	0x00		
0xE0002FE0	PID0	RO	0x03		
0xE0002FE4	PID1	RO	0xB0		
0xE0002FE8	PID2	RO	0x2B		
0xE0002FEC	PID3	RO	0x00		
0xE0002FF0	CID0	RO	0x0D	Component identification registers	
0xE0002FF4	CID1	RO	0xE0		
0xE0002FF8	CID2	RO	0x05		
0xE0002FFC	CID3	RO	0xB1		

All FPB registers are described in the *ARMv7-M Architecture Reference Manual*.

Chapter 8

Data Watchpoint and Trace Unit

This chapter describes the Data Watchpoint and Trace (DWT) unit.

It contains the following sections:

- [8.1 DWT functional description on page 8-73.](#)
- [8.2 DWT Programmers' model on page 8-74.](#)

8.1 DWT functional description

A full DWT contains four comparators that you can configure as hardware watchpoint, an ETM trigger, a PC sampler event trigger, or a data address sampler event trigger.

The first comparator, DWT_COMP0, can also compare against the clock cycle counter, CYCCNT. You can also use the second comparator, DWT_COMP1, as a data comparator.

A reduced DWT contains one comparator that you can use as a watchpoint or as a trigger. It does not support data matching.

The DWT, if present, contains counters for:

- Clock cycles (CYCCNT).
- Folded instructions.
- *Load Store Unit* (LSU) operations.
- Sleep cycles.
- CPI, that is all instruction cycles except for the first cycle.
- Interrupt overhead.

————— **Note** —————

An event is generated each time a counter overflows.

You can configure the DWT to generate PC samples at defined intervals, and to generate interrupt event information.

The DWT provides periodic requests for protocol synchronization to the ITM and the TPIU, if your implementation includes the Cortex-M3 TPIU.

8.2 DWT Programmers' model

Table showing the DWT registers. Depending on the implementation of your processor, some of these registers might not be present. Any register that is configured as not present reads as zero.

Table 8-1 DWT register summary

Address	Name	Type	Reset	Description
0xE0001000	DWT_CTRL	RW	Possible reset values are: <ul style="list-style-type: none"> • 0x40000000 if four comparators for watchpoints and triggers are present. • 0x4F000000 if four comparators for watchpoints only are present. • 0x10000000 if only one comparator is present. • 0x1F000000 if one comparator for watchpoints and not triggers is present. • 0x00000000 if DWT is not present. 	Control Register.
0xE0001004	DWT_CYCCNT	RW	0x00000000	Cycle Count Register
0xE0001008	DWT_CPICNT	RW	-	CPI Count Register
0xE000100C	DWT_EXCCNT	RW	-	Exception Overhead Count Register
0xE0001010	DWT_SLEEPCNT	RW	-	Sleep Count Register
0xE0001014	DWT_LSUCNT	RW	-	LSU Count Register
0xE0001018	DWT_FOLDCNT	RW	-	Folded-instruction Count Register
0xE000101C	DWT_PCSR	RO	-	Program Counter Sample Register
0xE0001020	DWT_COMP0	RW	-	Comparator Register0
0xE0001024	DWT_MASK0	RW	-	Mask Register0. The maximum mask size is 32KB.
0xE0001028	DWT_FUNCTION0	RW	0x00000000	Function Register0
0xE0001030	DWT_COMP1	RW	-	Comparator Register1
0xE0001034	DWT_MASK1	RW	-	Mask Register1. The maximum mask size is 32KB.
0xE0001038	DWT_FUNCTION1	RW	0x00000000	Function Register1
0xE0001040	DWT_COMP2	RW	-	Comparator Register2
0xE0001044	DWT_MASK2	RW	-	Mask Register2. The maximum mask size is 32KB.
0xE0001048	DWT_FUNCTION2	RW	0x00000000	Function Register2
0xE0001050	DWT_COMP3	RW	-	Comparator Register3
0xE0001054	DWT_MASK3	RW	-	Mask Register3. The maximum mask size is 32KB.
0xE0001058	DWT_FUNCTION3	RW	0x00000000	Function Register3

Table 8-1 DWT register summary (continued)

Address	Name	Type	Reset	Description
0xE0001FD0	PID4	RO	0x04	Peripheral identification registers
0xE0001FD4	PID5	RO	0x00	
0xE0001FD8	PID6	RO	0x00	
0xE0001FDC	PID7	RO	0x00	
0xE0001FE0	PID0	RO	0x02	
0xE0001FE4	PID1	RO	0xB0	
0xE0001FE8	PID2	RO	0x3B	
0xE0001FEC	PID3	RO	0x00	Component identification registers
0xE0001FF0	CID0	RO	0x0D	
0xE0001FF4	CID1	RO	0xE0	
0xE0001FF8	CID2	RO	0x05	
0xE0001FFC	CID3	RO	0xB1	

DWT registers are described in the *ARM[®]v7M Architecture Reference Manual*. Peripheral Identification and Component Identification registers are described in the *ARM[®] CoreSight[™] Components Technical Reference Manual*.

————— **Note** —————

- Cycle matching functionality is only available in comparator 0.
- Data matching functionality is only available in comparator 1.
- Data value is only sampled for accesses that do not produce an MPU or bus fault. The PC is sampled irrespective of any faults. The PC is only sampled for the first address of a burst.
- The FUNCTION field in the DWT_FUNCTION1 register is overridden for comparators given by DATAVADDR0 and DATAVADDR1 if DATAVMATCH is also set in DWT_FUNCTION1. The comparators given by DATAVADDR0 and DATAVADDR1 can then only perform address comparator matches for comparator 1 data matches.
- If the data matching functionality is not included during implementation it is not possible to set DATAVADDR0, DATAVADDR1, or DATAVMATCH in DWT_FUNCTION1. This means that the data matching functionality is not available in the implementation. Test the availability of data matching by writing and reading the DATAVMATCH bit in DWT_FUNCTION1. If this bit cannot be set then data matching is unavailable.
- ARM does not recommend PC match for watchpoints because it stops after the instruction. It mainly guards and triggers the ETM.

Chapter 9

Instrumentation Trace Macrocell Unit

This chapter describes the Instrumentation Trace Macrocell (ITM) unit.

It contains the following sections:

- *9.1 ITM functional description* on page 9-77.
- *9.2 ITM programmers' model* on page 9-78.
- *9.3 ITM Trace Privilege Register, ITM_TPR* on page 9-79.

9.1 ITM functional description

The ITM is an optional application-driven trace source that supports `printf()` style debugging to trace operating system and application events, and generates diagnostic system information. The ITM generates trace information as packets from software traces, hardware traces, time stamping, and global system timestamping sources.

The ITM generates trace information as packets. There are four sources that can generate packets. If multiple sources generate packets at the same time, the ITM arbitrates the order in which packets are output. The four sources in decreasing order of priority are:

- Software trace. Software can write directly to ITM stimulus registers to generate packets.
- Hardware trace. The DWT generates these packets, and the ITM outputs them.
- Time stamping. Timestamps are generated relative to packets. The ITM contains a 21-bit counter to generate the timestamp. The Cortex-M3 clock or the bitclock rate of the *Serial Wire Viewer* (SWV) output clocks the counter.

9.2 ITM programmers' model

Table showing the ITM registers. Depending on the implementation of your processor, the ITM registers might not be present. Any register that is configured as not present reads as zero.

————— **Note** —————

- You must enable TRCENA of the Debug Exception and Monitor Control Register before you program or use the ITM.
- If the ITM stream requires synchronization packets, you must configure the synchronization packet rate in the DWT.

Table 9-1 ITM register summary

Address	Name	Type	Reset	Description
0xE0000000- 0xE000007C	ITM_STIM0- ITM_STIM31	RW	-	Stimulus Port Registers 0-31
0xE0000E00	ITM_TER	RW	0x00000000	Trace Enable Register
0xE0000E40	ITM_TPR	RW	0x00000000	Refer to the ITM Trace Privilege Register description
0xE0000E80	ITM_TCR	RW	0x00000000	Trace Control Register
0xE0000FD0	PID4	RO	0x00000004	Peripheral Identification registers
0xE0000FD4	PID5	RO	0x00000000	
0xE0000FD8	PID6	RO	0x00000000	
0xE0000FDC	PID7	RO	0x00000000	
0xE0000FE0	PID0	RO	0x00000001	
0xE0000FE4	PID1	RO	0x000000B0	
0xE0000FE8	PID2	RO	0x0000003B	
0xE0000FEC	PID3	RO	0x00000000	
0xE0000FF0	CID0	RO	0x0000000D	Component Identification registers
0xE0000FF4	CID1	RO	0x000000E0	
0xE0000FF8	CID2	RO	0x00000005	
0xE0000FFC	CID3	RO	0x000000B1	

————— **Note** —————

ITM registers are fully accessible in privileged mode. In user mode, all registers can be read, but only the Stimulus Registers and Trace Enable Registers can be written, and only when the corresponding Trace Privilege Register bit is set. Invalid user mode writes to the ITM registers are discarded.

The following section describes the ITM registers whose implementation is specific to this processor. Other registers are described in the *ARM[®]v7-M Architectural Reference Manual*.

9.3 ITM Trace Privilege Register, ITM_TPR

Characteristics and bit assignments of the ITM_TPR register.

Purpose

Enables an operating system to control the stimulus ports that are accessible by user code.

Usage constraints

You can only write to this register in privileged mode.

Configurations

This register is available if the ITM is configured in your implementation.

Attributes

Refer to the ITM register summary table.

The following figure shows the ITM_TPR bit assignments.

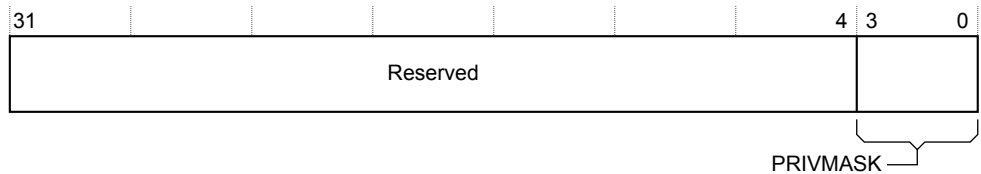

Figure 9-1 ITM_TPR bit assignments

The following table shows the ITM_TPR bit assignments.

Table 9-2 ITM_TPR bit assignments

Bits	Name	Function
[31:4]	-	Reserved.
[3:0]	PRIVMASK	Bit mask to enable tracing on ITM stimulus ports: bit [0] = stimulus ports [7:0] bit [1] = stimulus ports [15:8] bit [2] = stimulus ports [23:16] bit [3] = stimulus ports [31:24].

Chapter 10

Embedded Trace Macrocell

This chapter describes the Embedded Trace Macrocell (ETM).

It contains the following sections:

- *10.1 About the ETM on page 10-81.*
- *10.2 ETM functional description on page 10-82.*
- *10.3 ETM Programmers model on page 10-88.*

10.1 About the ETM

The ETM is an optional debug component that enables reconstruction of program execution. The ETM is designed to be a high-speed, low-power debug tool that only supports instruction trace. This ensures that area is minimized, and that gate count is reduced.

This section contains the following subsections:

- [10.1.1 ETM architecture on page 10-81.](#)
- [10.1.2 ETM features list on page 10-81.](#)
- [10.1.3 Configurable options list on page 10-81.](#)

10.1.1 ETM architecture

The ETM implements ARM ETM architecture v3.5.

The ETM traces all 32-bit Thumb instructions as a single instruction. The ETM traces instructions following an IT instruction as normal conditional instructions. The decompressor does not need to refer to the IT instruction.

You can use the CoreSight ETM-M3 either with the Cortex-M3 *Trace Port Interface Unit* (M3-TPIU), or as part of a CoreSight system.

For more information, see the *ARM® Embedded Trace Macrocell Architecture Specification*.

10.1.2 ETM features list

List of features provided by the ETM component.

ETM-M3 provides:

- Tracing of 16-bit and 32-bit Thumb instructions.
- Four EmbeddedICE watchpoint inputs.
- A Trace Start/Stop block with EmbeddedICE inputs.
- Two external inputs.
- A 24-byte FIFO queue.
- Global timestamping.

See the *Embedded Trace Macrocell Architecture Specification* for information about:

- The trace protocol.
- Controlling tracing using triggering and filtering resources.

See the *Cortex®-M3 Integration and Implementation Manual* for information about the macrocell signals.

10.1.3 Configurable options list

List of configuration inputs provided by the ETM component.

The ETM-M3 macrocell includes the following configuration inputs:

- The maximum number of external inputs.
- Whether the system supports the FIFOFULL mechanism for stalling the processor.

Related concepts

[10.2.7 External inputs on page 10-85.](#)

10.2 ETM functional description

The ETM receives input from the processor and outputs trace information to the TPIU or CoreSight system. ETM trace output is compatible with the AMBA Trace Bus (ATB) protocol.

This section contains the following subsections:

- [10.2.1 ETM block diagram on page 10-82.](#)
- [10.2.2 Low-bandwidth data tracing on page 10-82.](#)
- [10.2.3 Resources on page 10-83.](#)
- [10.2.4 Timestamp format on page 10-85.](#)
- [10.2.5 Periodic synchronization on page 10-85.](#)
- [10.2.6 Data and instruction address compare resources on page 10-85.](#)
- [10.2.7 External inputs on page 10-85.](#)
- [10.2.8 Start/stop block on page 10-85.](#)
- [10.2.9 Triggering on page 10-86.](#)
- [10.2.10 Interfaces on page 10-86.](#)
- [10.2.11 Operation on page 10-87.](#)

10.2.1 ETM block diagram

Block diagram of the ETM, showing how the ETM interfaces to the Trace Port Interface Unit (TPIU).

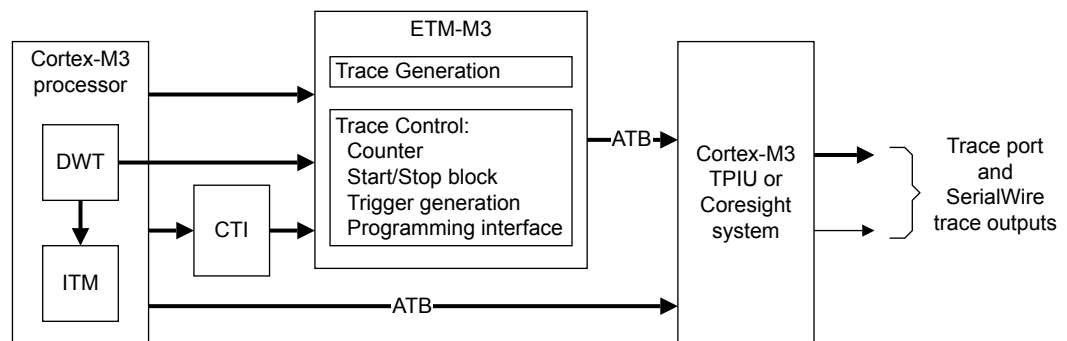

Figure 10-1 ETM block diagram

10.2.2 Low-bandwidth data tracing

The Cortex-M3 system can perform low-bandwidth data tracing using the Data Watchpoint and Trace (DWT) and Instruction Trace Macrocell (ITM) components.

The ETM trace output is compatible with the *AMBA Trace Bus* (ATB) protocol, irrespective of the configuration of the trace port size and trace port mode within the ETM programmers model. The TPIU exports trace information from the processor. An implementation can replace the TPIU with other CoreSight trace components.

The ETM provides a trace ID register for systems that use multiple trace sources. You must configure this register even if only a single trace source is in use.

Related concepts

- [10.2.5 Periodic synchronization on page 10-85.](#)
- [10.2.6 Data and instruction address compare resources on page 10-85.](#)
- [10.2.7 External inputs on page 10-85.](#)
- [10.2.8 Start/stop block on page 10-85.](#)
- [10.2.9 Triggering on page 10-86.](#)
- [10.2.10 Interfaces on page 10-86.](#)
- [10.2.11 Operation on page 10-87.](#)

Related references

Chapter 8 Data Watchpoint and Trace Unit on page 8-72.

Chapter 9 Instrumentation Trace Macrocell Unit on page 9-76.

Chapter 11 Trace Port Interface Unit on page 11-103.

10.2.3 Resources on page 10-83.

10.2.3 Resources

Because the ETM does not generate data trace information, the lower bandwidth reduces the requirement for complex triggering capabilities. This means that the ETM only includes a small subset of the possible resources allowed by the ETM architecture.

The following table lists the processor resources present on the ETM.

Table 10-1 Cortex-M3 resources

Feature	Present on ETM-M3
Architecture version	ETMv3.5
Address comparator pairs	0
Data comparators	0
Context ID comparators	0
<i>Memory Map Decoders (MMDs)</i>	0
Counters	1, reduced function counter only
Sequencer	No
Start/stop block	Yes
Embedded ICE comparators	4
External inputs	2
External outputs	0
Extended external inputs	0
Extended external input selectors	0
FIFOFULL	Yes
FIFOFULL level setting	Yes
Branch broadcasting	Yes
ASIC Control Register	No
Data suppression	No
Software access to registers	Yes
Readable registers	Yes
FIFO size	24 bytes
Minimum port size	8 bits
Maximum port size	8 bits
Normal port mode	-
Normal half-rate clocking, 1:1	Yes - asynchronous
Demux port mode	-

Table 10-1 Cortex-M3 resources (continued)

Feature	Present on ETM-M3
Demux half-rate clocking, 1:2	No
Mux port mode, 2:1	No
1:4 port mode	No
Dynamic port mode, including stalling	No. Supported by asynchronous port mode.
<i>Coprocessor Register Transfer</i> (CPRT) data	No
Load PC first	No
Fetch comparisons	No
Load data traced	No

Resource identification encoding

You configure the trace enable event and trigger event using the same mechanism. For each event, a 17-bit register is used to define the event.

This register provides:

- Resource A, bits [6:0].
- Resource B, bits [13:7].
- A Boolean function, bits [16:14].

The following table shows the encodings used for Resource identification. Note that for the resource type, Resource A, bits [6:4], and for Resource B, bits [13:11]; for the index range, Resource A, bits [3:0], and for Resource B, bits [10:7].

Table 10-2 Resource identification encoding

Resource type	Index range	Description of resource type
0b010	0-3	DWT Comparator inputs (0-3)
0b100	0	Counter 1 at zero
0b101	15	Trace Start/Stop resource
0b110	0-1	ExtIn (0-1)
0b110	15	HardWired (always True)

The following table shows the encodings used for the Boolean function.

Table 10-3 Boolean function encoding for events

Encoding	Function
0b000	A
0b001	NOT(A)
0b010	A AND B
0b011	NOT(A) AND B
0b100	NOT(A) AND NOT (B)
0b101	A OR B

Table 10-3 Boolean function encoding for events (continued)

Encoding Function	
0b110	NOT (A) OR B
0b111	NOT (A) OR NOT (B)

10.2.4 Timestamp format

Timestamps are encoded as 48-bit natural binary numbers.

A system implementation may provide a timestamp count which can be used by several trace sources as an aid to correlating the trace streams.

10.2.5 Periodic synchronization

The ETM uses a fixed synchronization packet generation frequency of every 1024 bytes of trace.

10.2.6 Data and instruction address compare resources

The DWT provides four address comparators on the data bus that provide debug functionality.

Within the DWT unit, you can specify the functions triggered by a match, and one of these functions is to generate an ETM match input. These inputs are presented to the ETM as Embedded *In Circuit Emulator* (ICE) comparator inputs.

A single DWT resource can trigger an ETM event and also generate instrumentation trace directly from the same event.

You can configure the four DWT comparators individually to compare with the address of the current executing instruction to permit the ETM access to an instruction address compare resource. These inputs are presented to the ETM as Embedded ICE comparator inputs. The DWT provides either one or four comparators, depending on the implementation of the processor.

————— **Note** —————

Using a DWT comparator as an instruction address comparator reduces the number of available data address comparisons.

Related references

[Chapter 8 Data Watchpoint and Trace Unit on page 8-72.](#)

10.2.7 External inputs

Two external inputs, ETMEXTIN[1:0], enable additional components to generate trigger and enable signals for the ETM.

10.2.8 Start/stop block

The start/stop block provides a single-bit resource that can be used as an input to other parts of the resource logic, including the trace enable logic.

The start/stop block can only be controlled by using the EmbeddedICE inputs to the ETM. The DWT controls these inputs.

The start/stop block is set to the start state if any of the EmbeddedICE watchpoint inputs selected as start resources in ETMTESSEICR go HIGH. The start/stop block is set to the stop state if any of the EmbeddedICE watchpoint inputs selected as stop resources in ETMTESSEICR go LOW.

If bit [25] of ETMTECR1 is 1, tracing will only be enabled when the start/stop block is in the start state.

Tracing is also only enabled when the result of evaluating the Trace Enable Event is TRUE. This event can be set to always be TRUE by programming a value of 0x6F to ETMTTEVR. For more information see the *Embedded Trace Macrocell Architecture Specification*.

10.2.9 Triggering

The ETM provides a trigger resource that can be used to identify a point within a trace run.

The generation of a trigger does not affect the tracing in any way, but the trigger will be output in the trace stream, and can also be passed to other trace components or used to halt the processor. An external trace port analyzer can use the trigger to determine when to start and stop capture of trace.

10.2.10 Interfaces

The ETM provides three external interfaces which provide a trace output from the macrocell, a control interface for the macrocell, and an interface to manage the interconnection of trigger and control signals between the processor core, ETM, and TPIU.

The ETM-M3 has the following external interfaces:

ATB

A 32-bit *Advanced Trace Bus* provides trace output from the macrocell. See the *AMBA 3 ATB Protocol Specification* for more information about this interface.

APB

An *Advanced Peripheral Bus* provides the control interface for the macrocell. See the *AMBA 3 APB Protocol Specification* for more information about this interface.

CTI

Your implementation can provide a *Cross Trigger Interface* to manage the interconnection of trigger and control signals between the processor core, ETM, and TPIU. The implementation of your Cortex-M3 processor determines which ETM functions are visible to the CTI.

Table of recommended CTI connections

Tables showing the recommended CTI connections for Cortex-M3 systems.

————— **Note** —————

These tables show the ARM standard connections, but the actual connections are implementation-defined. Refer to documentation from the supplier of your device for any changes to these connections.

Table 10-4 Input connections

Trigger bit	Source signal	Source device	Comments
[7]	ETMTRIGOUT	ETM	Recommended if ETM is present.
[6]	ETMTRIGGER[2]	DWT	Recommended.
[5]	ETMTRIGGER[1]	DWT	Recommended.
[4]	ETMTRIGGER[0]	DWT	Recommended.
[3]	ACQCOMP	ETB	Recommended if an <i>Embedded Trace Buffer</i> (ETB) is present. If multiple cores share a single ETB, you must only connect to the CTI of one of the cores.
[2]	FULL	ETB	
[1]	User Defined	-	-
[0]	HALTED	Core	Compulsory.

Table 10-5 Trigger output connections

Trigger bit	Destination signal	Destination device	Comments
[7]	User defined	-	-
[6]	User defined	-	-
[5]	ETMEXTIN[1]	ETM	Compulsory if ETM is present.
[4]	ETMEXTIN[0]	ETM	Compulsory if ETM is present.
[3]	INTISR[y]	NVIC	Recommended if an ETB is present. If multiple cores share a single ETB, you must only connect to the CTI of one of the cores.
[2]	INTISR[x]	NVIC	Compulsory. Any interrupt can be used.
[1]	User defined	-	-
[0]	EDBGRQ	Core	Compulsory.

10.2.11 Operation

ETM-M3 implements version 3.5 of the ARM Embedded Trace Macrocell protocol.

10.3 ETM Programmers model

The ETM programmers model provides mechanisms for programming the registers used to set up the trace and triggering facilities of the macrocell.

This section contains the following subsections:

- [10.3.1 Modes of operation and execution on page 10-88.](#)
- [10.3.2 ETM register summary table on page 10-88.](#)
- [10.3.3 Main Control Register, ETMCR on page 10-90.](#)
- [10.3.4 Configuration Code Register, ETMCCR on page 10-93.](#)
- [10.3.5 System Configuration Register, ETMSCR on page 10-94.](#)
- [10.3.6 TraceEnable Control 1 Register, ETMTECR1 characteristics on page 10-95.](#)
- [10.3.7 ID Register, ETMIDR characteristics on page 10-95.](#)
- [10.3.8 Configuration Code Extension Register, ETMCCER characteristics on page 10-96.](#)
- [10.3.9 TraceEnable Start/Stop EmbeddedICE Control Register, ETMTESSEICR on page 10-98.](#)
- [10.3.10 Device Power-Down Status Register, ETMPDSR on page 10-99.](#)
- [10.3.11 Integration Test Miscellaneous Inputs, ITMISCIN on page 10-99.](#)
- [10.3.12 Integration Test Trigger Out, ITTRIGOUT on page 10-100.](#)
- [10.3.13 ETM Integration Test ATB Control 2, ETM_ITATBCTR2 on page 10-101.](#)
- [10.3.14 ETM Integration Test ATB Control 0, ETM_ITATBCTR0 on page 10-101.](#)

10.3.1 Modes of operation and execution

On power-up or reset of the ETM you must program all registers which do not have an architected reset state before enabling tracing, and enable all register changes at the same time using the Programming bit in ETMCR.

ETM-M3 implements ETMv3.5 for tracing 16-bit and 32-bit Thumb instructions. The *Embedded Trace Macrocell Architecture Specification* describes the features of ETMv3.5.

When the ETM is powered up or reset, you must program all of the registers that do not have an architected reset state before you enable tracing. If you do not do so, the trace results are Unpredictable.

When programming the ETM registers you must enable all the changes at the same time. To achieve this, use the Programming bit in ETMCR.

When the Programming bit is set to 0 you must not write to registers other than ETMCR, because this can lead to Unpredictable behavior.

When setting the Programming bit, you must not change any other bits of ETMCR. You must only change the value of bits other than the Programming bit of ETMCR when bit [1] of ETMSR is set to 1. ARM recommends that you use a read-modify-write procedure when changing ETMCR.

Related references

- [10.1.2 ETM features list on page 10-81.](#)
- [10.3.3 Main Control Register, ETMCR on page 10-90.](#)

10.3.2 ETM register summary table

Table of ETM registers with register address, name, reset, type, and description information.

Table 10-6 ETM registers

Address	Name	Reset	Type	Description
0xE0041000	ETMCR	0x00000411	RW	Main Control Register, ETMCR
0xE0041004	ETMCCR	0x8C802000	RO	Configuration Code Register, ETMCCR

Table 10-6 ETM registers (continued)

Address	Name	Reset	Type	Description
0xE0041008	ETMTRIGGER	-	RW	Trigger Event Register. See <i>ARM® Embedded Trace Macrocell Architecture Specification</i>
0xE0041010	ETMSR	-	RW	ETM Status Register. See <i>ARM® Embedded Trace Macrocell Architecture Specification</i>
0xE0041014	ETMSCR	0x00020D09	RO	System Configuration Register, ETMSCR
0xE0041020	ETMTSEVR	-	RW	TraceEnable Event Register. See <i>ARM® Embedded Trace Macrocell Architecture Specification</i>
0xE0041024	ETMTECR1	-	RW	TraceEnable Control 1 Register, ETMTECR1
0xE0041028	ETMFFLR	-	RW	FIFOFULL Level Register. See <i>ARM® Embedded Trace Macrocell Architecture Specification</i>
0xE0041140	ETMCNTRLDVR1	-	RW	Free-running counter reload value
0xE00411E0	ETMSYNCFR	0x00000400	RO	Synchronisation Frequency Register. See <i>ARM® Embedded Trace Macrocell Architecture Specification</i>
0xE00411E4	ETMIDR	0x4114F253	RO	ID Register, ETMIDR
0xE00411E8	ETMCCER	0x18541800	RO	Configuration Code Extension Register, ETMCCER
0xE00411F0	ETMTESSEICR	-	RW	TraceEnable Start/Stop EmbeddedICE Control Register, ETMTESSEICR
0xE00411F8	ETMTSEVR	-	RW	Timestamp Event Register. See <i>ARM® Embedded Trace Macrocell Architecture Specification</i>
0xE0041200	ETMTRACEIDR	0x00000000	RW	CoreSight Trace ID Register. See <i>ARM® Embedded Trace Macrocell Architecture Specification</i>
0xE0041208	ETMIDR2	0x00000000	RO	ETM ID Register 2. See <i>ARM® Embedded Trace Macrocell Architecture Specification</i>
0xE0041314	ETMPDSR	0x00000001	RO	Device Power-Down Status Register, ETMPDSR
0xE0041EE0	ITMISCIN	-	RO	Integration Test Miscellaneous Inputs, ITMISCIN
0xE0041EE8	ITTRIGOUT	-	WO	Integration Test Trigger Out, ITTRIGOUT
0xE0041EF0	ETM_ITATBCTR2	-	RO	ETM Integration Test ATB Control 2, ETM_ITATBCTR2
0xE0041EF8	ETM_ITATBCTR0	-	WO	ETM Integration Test ATB Control 0, ETM_ITATBCTR0
0xE0041F00	ETMITCTRL	0x00000000	RW	Integration Mode Control Register. See <i>ARM® Embedded Trace Macrocell Architecture Specification</i>
0xE0041FA0	ETMCLAIMSET	-	RW	Claim Tag Set Register. See <i>ARM® Embedded Trace Macrocell Architecture Specification</i>
0xE0041FA4	ETMCLAIMCLR	-	RW	Claim Tag Clear Register. See <i>ARM® Embedded Trace Macrocell Architecture Specification</i>
0xE0041FB0	ETMLAR	-	RW	Lock Access Register. See <i>ARM® Embedded Trace Macrocell Architecture Specification</i>
0xE0041FB4	ETMLSR	-	RO	Lock Status Register. See <i>ARM® Embedded Trace Macrocell Architecture Specification</i>
0xE0041FB8	ETMAUTHSTATUS	-	RO	Authentication Status Register. See <i>ARM® Embedded Trace Macrocell Architecture Specification</i>

Table 10-6 ETM registers (continued)

Address	Name	Reset	Type	Description
0xE0041FCC	ETMDEVTYPE	0x00000013	RO	CoreSight Device Type Register. See <i>ARM® Embedded Trace Macrocell Architecture Specification</i>
0xE0041FD0	ETMPIDR4	0x00000004	RO	Peripheral Identification registers. See <i>ARM® Embedded Trace Macrocell Architecture Specification</i>
0xE0041FD4	ETMPIDR5	0x00000000	RO	
0xE0041FD8	ETMPIDR6	0x00000000	RO	
0xE0041FDC	ETMPIDR7	0x00000000	RO	
0xE0041FE0	ETMPIDR0	0x00000024	RO	
0xE0041FE4	ETMPIDR1	0x000000B9	RO	
0xE0041FE8	ETMPIDR2	0x0000003B	RO	
0xE0041FEC	ETMPIDR3	0x00000000	RO	
0xE0041FF0	ETMCIDR0	0x0000000D	RO	Component Identification registers. See <i>ARM® Embedded Trace Macrocell Architecture Specification</i>
0xE0041FF4	ETMCIDR1	0x00000090	RO	
0xE0041FF8	ETMCIDR2	0x00000005	RO	
0xE0041FFC	ETMCIDR3	0x000000B1	RO	

10.3.3 Main Control Register, ETMCR

Characteristics and bit assignments of the ETM Main Control Register (ETMCR).

Purpose

Controls general operation of the ETM, such as whether tracing is enabled.

Usage constraints

There are no usage constraints.

Configurations

This register is only available if the processor is configured to use the ETM.

Attributes

See the ETM register summary.

ETMCR bit assignments are shown in the following figure and table.

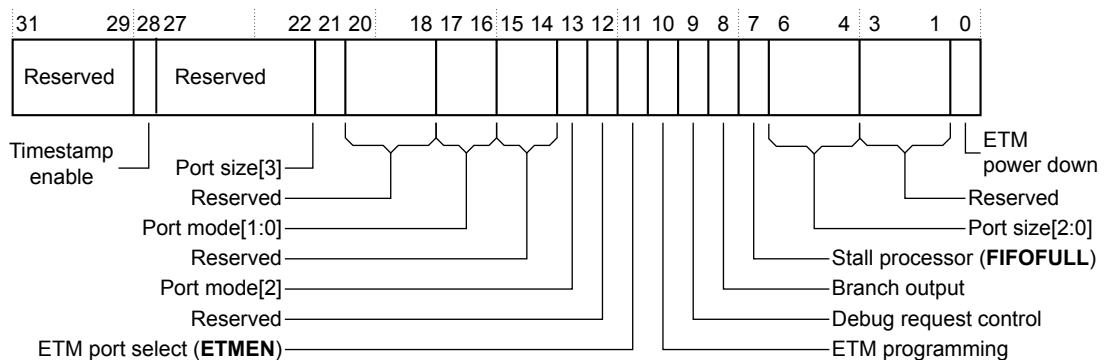

Figure 10-2 ETMCR bit assignments

Table 10-7 ETMCR bit assignments

Bits	Name	Function
[31:29]	-	RAZ
[28]	Timestamp enable	When set, this bit enables timestamping. An ETM reset sets this bit to 0.
[27:22]	-	Reserved
[21]	Port size[3]	This bit is implemented but has no function. An ETM reset sets this bit to 0.
[20:18]	-	Reserved
[17:16]	Port mode [1:0]	These bits are implemented but have no function. An ETM reset sets these bits to 0.
[15:14]	-	Reserved
[13]	Port mode[2]	This bit is implemented but has no function. An ETM reset sets this bit to 0.
[12]	-	Reserved
[11]	ETM port selection	This bit can be used to control other trace components in an implementation. The possible values are: 0 ETMEN is LOW. 1 ETMEN is HIGH. This bit must be set by the trace software tools to ensure that trace output is enabled from this ETM. An ETM reset sets this bit to 0.
[10]	ETM programming	This bit must be set to 1 at the start of the ETM programming sequence. Tracing is prevented while this bit is set to 1. On an ETM reset this bit is set to 0b1.
[9]	Debug request control	When set to 1 and the trigger event occurs, the DBGREQ output is asserted until DBGACK is observed. This enables the ARM processor to be forced into Debug state. An ETM reset sets this bit to 0.
[8]	Branch output	When set to 1 all branch addresses are output, even if the branch was because of a direct branch instruction. Setting this bit enables reconstruction of the program flow without having access to the memory image of the code being executed. When this bit is set to 1, more trace data is generated, and this may affect the performance of the trace system. Information about the execution of a branch is traced regardless of the state of this bit. An ETM reset sets this bit to 0.

Table 10-7 ETMCR bit assignments (continued)

Bits	Name	Function
[7]	Stall processor	<p>The FIFOFULL output can be used to stall the processor to prevent overflow. The FIFOFULL output is only enabled when the stall processor bit is set to 1. When the bit is 0 the FIFOFULL output remains LOW at all times and the FIFO overflows if there are too many trace packets. Trace resumes without corruption after the FIFO has drained, if overflow does occur.</p> <p>An ETM reset sets this bit to 0.</p> <p>For information about the interaction of this bit with the ETMFLLR register see the <i>Embedded Trace Macrocell Architecture Specification</i>.</p>
[6:4]	Port size [2:0]	<p>The ETM-M3 has no influence over the external pins used for trace. These bits are implemented but not used.</p> <p>On an ETM reset these bits reset to 0b001.</p>
[3:1]	-	Reserved
[0]	ETM power down	<p>This bit can be used by an implementation to control whether the ETM is in a low power state. This bit must be cleared by the trace software tools at the beginning of a debug session.</p> <p>When this bit is set to 1, writes to some registers and fields might be ignored. You can always write to the following registers and fields:</p> <ul style="list-style-type: none"> • ETMCR bit [0]. • ETMLAR. • ETMCLAIMSET register. • ETMCLAIMCLR register. <p>When the ETMCR is written with this bit set to 1, bits other than bit [0] might be ignored.</p> <p>On an ETM reset this bit is set to 1.</p>

10.3.4 Configuration Code Register, ETMCCR

Characteristics and bit assignments of the Configuration Code Register (ETMCCR).

The ETMCCR characteristics are:

Purpose

Enables software to read the implementation-specific configuration of the ETM.

Usage constraints

There are no usage constraints.

Configurations

This register is only available if the processor is configured to use the ETM.

Attributes

Refer to the ETM register summary table.

ETMCCR bit assignments are shown in the following figure and table.

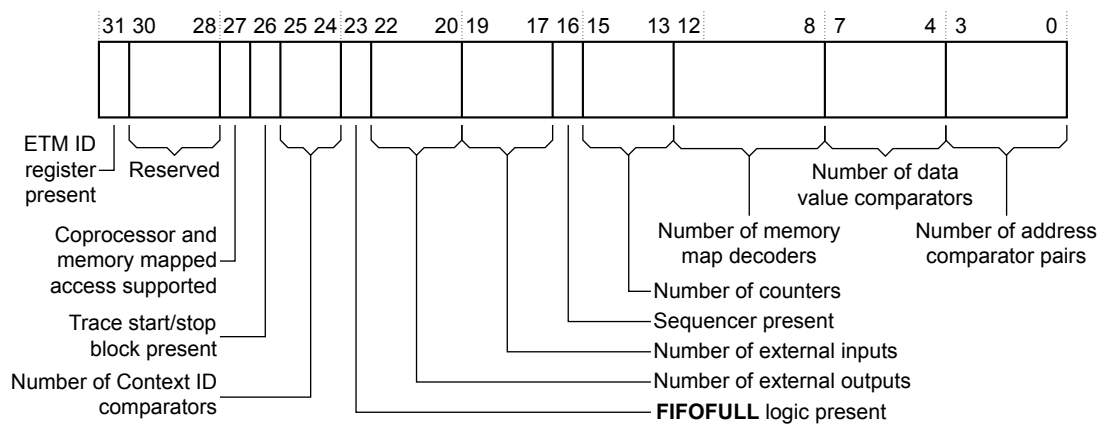

Figure 10-3 ETMCCR bit assignments

Table 10-8 ETMCCR bit assignments

Bits	Name	Function
[31]	ETM ID register present	The value of this bit is 1, indicating that the ETMIDR, register 0x79, is present and defines the ETM architecture version in use.
[30:28]	-	Reserved.
[27]	Coprocessor and memory access	The value of this bit is 1, indicating that memory-mapped access to registers is supported.
[26]	Trace start/stop block present	The value of this bit is 1, indicating that the Trace start/stop block is present.
[25:24]	Number of Context ID comparators	The value of these bits is 0b00, indicating that Context ID comparators are not implemented.
[23]	FIFOFULL logic present	The value of this bit is 1, indicating that FIFOFULL logic is present in the ETM. To use FIFOFULL the system must also support the function, as indicated by bit [8] of ETMSCR.
[22:20]	Number of external outputs	The value of these bits is 0b000, indicating that no external outputs are supported.
[19:17]	Number of external inputs	The value of these bits is between 0b000 and 0b010, indicating the number of external inputs, from 0 to 2, implemented in the system.
[16]	Sequencer present	The value of this bit is 0, indicating that the sequencer is not implemented.
[15:13]	Number of counters	The value of these bits is 0b001, indicating that one counter is implemented.
[12:8]	Number of memory map decoders	The value of these bits is 0b00000, indicating that memory map decoder inputs are not implemented.

Table 10-8 ETMCCR bit assignments (continued)

Bits	Name	Function
[7:4]	Number of data value comparators	The value of these bits is 0b0000, indicating that data value comparators are not implemented.
[3:0]	Number of address comparator pairs	The value of these bits is 0b0000, indicating that address comparator pairs are not implemented.

10.3.5 System Configuration Register, ETMSCR

Characteristics and bit assignments of the System Configuration Register (ETMSCR).

The ETMSCR characteristics are:

Purpose

Shows the ETM features supported by the implementation of the ETM macrocell.

Usage constraints

There are no usage constraints.

Configurations

This register is only available if the processor is configured to use the ETM.

Attributes

Refer to the ETM register summary table.

ETMSCR bit assignments are shown in the following figure and table.

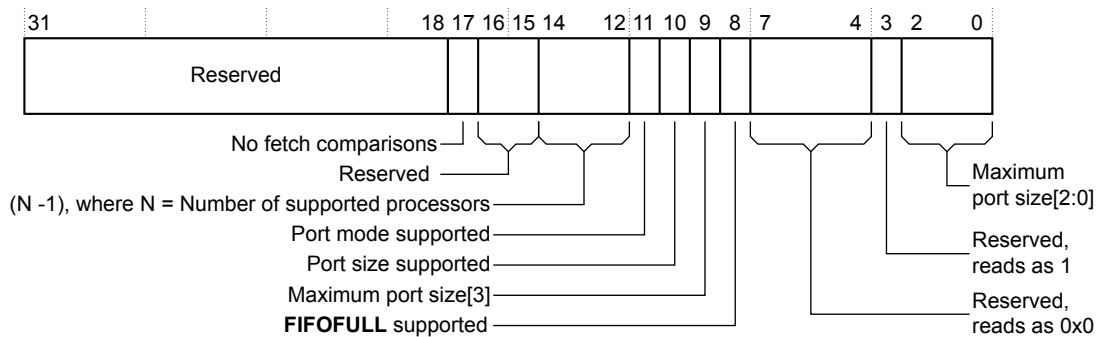

Figure 10-4 ETMSCR bit assignments

Table 10-9 ETMSCR bit assignments

Bits	Name	Function
[31:18]	-	Reserved.
[17]	No Fetch comparisons	The value of this bit is 1, indicating that fetch comparisons are not implemented.
[16:15]	-	Reserved.
[14:12]	(N-1)	These bits give the number of supported processors minus 1. The value of these bits is 0b000, indicating that there is only one processor connected.
[11]	Port mode supported	This bit reads as 1 if the currently selected port mode is supported. This has no effect on the TPIU trace port.
[10]	Port size supported	This bit reads as 1 if the currently selected port size is supported. This has no effect on the TPIU trace port.
[9]	Maximum port size [3]	Maximum ETM port size bit [3]. This bit is used in conjunction with bits [2:0]. Its value is 0. This has no effect on the TPIU trace port.

Table 10-9 ETMSCR bit assignments (continued)

Bits	Name	Function
[8]	FIFOFULL supported	The value of this bit is 1, indicating that FIFOFULL is supported. This bit is used in conjunction with bit [23] of the ETMCCR.
[7:4]	-	Reserved, Read-As-Zero.
[3]	-	Reserved, Read-As-One.
[2:0]	Maximum port size [2:0]	Maximum ETM port size bits [2:0]. These bits are used in conjunction with bit [9]. The value of these bits is 0b001 .

10.3.6 TraceEnable Control 1 Register, ETMTECR1 characteristics

Characteristics and bit assignments of the TraceEnable Control 1 Register (ETMTECR1).

The ETMTECR1 characteristics are:

Purpose

Enables the start/stop logic used for trace enable.

Usage constraints

There are no usage constraints.

Configurations

This register is only available if the processor is configured to use the ETM.

Attributes

Refer to the ETM register summary table.

ETMTECR1 bit assignments are shown in the following figure and table.

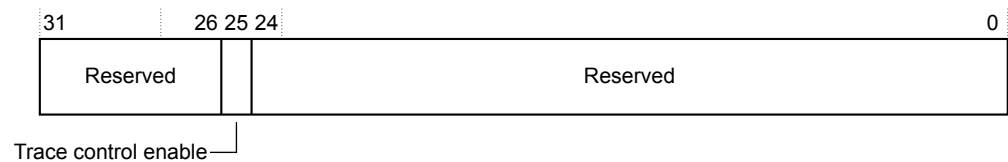

Figure 10-5 ETMTECR1 bit assignments

Table 10-10 ETMTECR1 bit assignments

Bits	Name	Function
[31:26]	-	Reserved.
[25]	Trace control enable	Trace start/stop enable. The possible values of this bit are: 0 Tracing is unaffected by the trace start/stop logic. 1 Tracing is controlled by the trace on and off addresses configured for the trace start/stop logic. The trace start/stop resource, resource 0x5F , is unaffected by the value of this bit.
[24:0]	-	Reserved.

10.3.7 ID Register, ETMIDR characteristics

Characteristics and bit assignments of the ID Register (ETMIDR).

The ETMIDR characteristics are:

Purpose

Holds the ETM architecture variant, and defines the programmers model for the ETM.

Usage constraints

There are no usage constraints.

Configurations

This register is only available if the processor is configured to use the ETM.

Attributes

Refer to the ETM register summary table.

ETMIDR bit assignments are shown in the following figure and table.

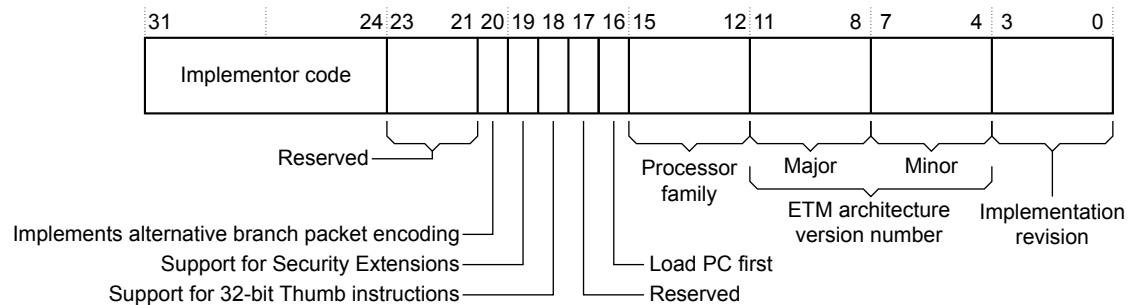

Figure 10-6 ETMIDR bit assignments

Table 10-11 ETMIDR bit assignments

Bits	Name	Function
[31:24]	Implementer code	These bits identify ARM as the implementer of the processor. The value of these bits is 0b01000001.
[23:21]	-	Reserved.
[20]	Branch packet encoding	The value of this bit is 1, indicating that alternative branch packet encoding is implemented.
[19]	Security Extensions support	The value of this bit is 0, indicating that the ETM behaves as if the processor is in Secure state at all times.
[18]	32-bit Thumb instruction tracing	The value of this bit is 1, indicating that a 32-bit Thumb instruction is traced as a single instruction.
[17]	-	Reserved.
[16]	Load PC first	The value of this bit is 0, indicating that data tracing is not supported.
[15:12]	Processor family	The value of these bits is 0b1111, indicating that the processor family is not identified in this register.
[11:8]	Major ETM architecture version	The value of these bits is 0b0010, indicating major architecture version number 3, ETMv3.
[7:4]	Minor ETM architecture version	The value of these bits is 0b0101, indicating minor architecture version number 5.
[3:0]	Implementation revision	The value of these bits is 0b0011, indicating implementation revision, 3.

10.3.8 Configuration Code Extension Register, ETMCCER characteristics

Characteristics and bit assignments of the Configuration Code Extension Register (ETMCCER).

The ETMCCER characteristics are:

Purpose

Holds ETM configuration information additional to that in the ETMCCR.

Usage constraints

There are no usage constraints.

Configurations

This register is only available if the processor is configured to use the ETM.

Attributes

Refer to the ETM register summary table.

ETMCCER bit assignments are shown in the following figure and table.

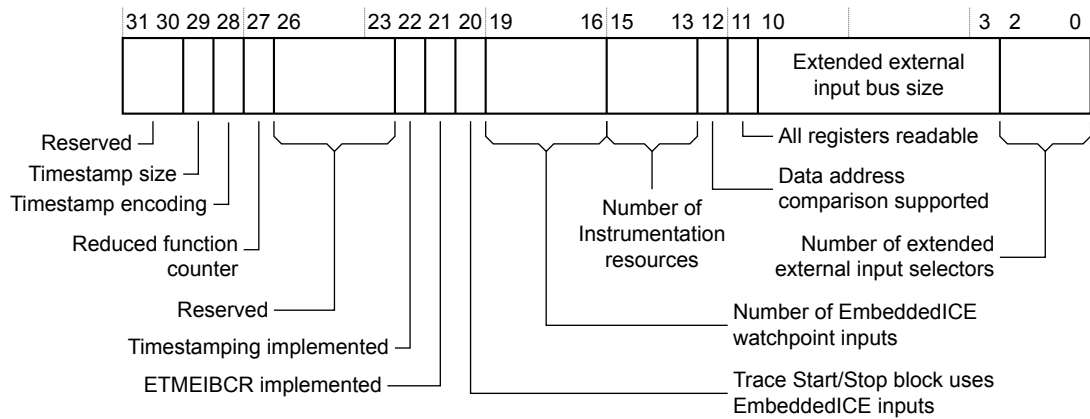

Figure 10-7 ETMCCER bit assignments

Table 10-12 ETMCCER bit assignments

Bits	Name	Function
[31:30]	-	Reserved. Read-As-Zero.
[29]	Timestamp size	Set to 0 to indicate a size of 48 bits.
[28]	Timestamp encoding	Set to 1 to indicate that the timestamp is encoded as a natural binary number.

Table 10-12 ETMCCER bit assignments (continued)

Bits	Name	Function
[27]	Reduced function counter	Set to 1 to indicate that Counter 1 is a reduced function counter.
[26:23]	-	Reserved, Read-As-Zero.
[22]	Timestamping implemented	This bit is set to 1, indicating that timestamping is implemented.
[21]	EmbeddedICE behavior control implemented	The value of this bit is 0, indicating that the ETMEIBCR is not implemented. For more information on EmbeddedICE behavior see the <i>Embedded Trace Macrocell Architecture Specification</i> .
[20]	Trace Start/Stop block uses EmbeddedICE watchpoint inputs	The value of this bit is 1, indicating that the Trace Start/Stop block uses the EmbeddedICE watchpoint inputs.
[19:16]	EmbeddedICE watchpoint inputs	The value of these bits is 0b0100 , indicating that the number of EmbeddedICE watchpoint inputs implemented is four. These inputs come from the DWT.
[15:13]	Instrumentation resources	The value of these bits is 0b000 , indicating that no Instrumentation resources are supported.
[12]	Data address comparisons	The value of this bit is 1, indicating that data address comparisons are not supported.
[11]	Readable registers	The value of this bit is 1, indicating that all registers are readable.
[10:3]	Extended external input bus	The value of these bits is 0, indicating that the extended external input bus is not implemented.
[2:0]	Extended external input selectors	The value of these bits is 0, indicating that extended external input selectors are not implemented.

10.3.9 TraceEnable Start/Stop EmbeddedICE Control Register, ETMTESSEICR

Characteristics and bit assignments of the TraceEnable Start/Stop EmbeddedICE Control Register (ETMTESSEICR).

The ETMTESSEICR characteristics are:

Purpose

Specifies the EmbeddedICE watchpoint comparator inputs that are used to control the start/stop resource.

Usage constraints

There are no usage constraints.

Configurations

This register is only available if the processor is configured to use the ETM.

Attributes

Refer to the ETM register summary table.

ETMTESSEICR bit assignments are shown in the following figure and table.

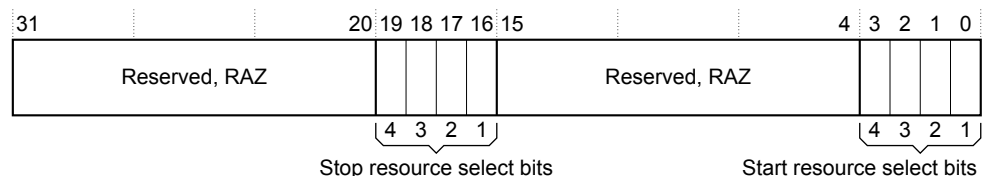

Figure 10-8 ETMTESSEICR bit assignments

Table 10-13 ETMTESSEICR bit assignments

Bits	Name	Function
[31:20]	-	Reserved, Read-as-zero.
[19:16]	Stop resource selection	Setting any of these bits to 1 selects the corresponding EmbeddedICE watchpoint input as a TraceEnable stop resource. Bit [16] corresponds to input 1, bit [17] corresponds to input 2, bit [18] corresponds to input 3, and bit [19] corresponds to input 4.
[15:4]	-	Reserved, Read-As-Zero.
[3:0]	Start resource selection	Setting any of these bits to 1 selects the corresponding EmbeddedICE watchpoint input as a TraceEnable start resource. Bit [0] corresponds to input 1, bit [1] corresponds to input 2, bit [2] corresponds to input 3, and bit [3] corresponds to input 4.

10.3.10 Device Power-Down Status Register, ETMPDSR

Characteristics and bit assignments of the Device Power-Down Status Register (ETMPDSR).

The ETMPDSR characteristics are:

Purpose

Indicates the power-down status of the ETM.

Usage constraints

There are no usage constraints.

Configurations

This register is only available if the processor is configured to use an ETM.

Attributes

Refer to the ETM register summary table.

ETMPDSR bit assignments are shown in the following figure and table.

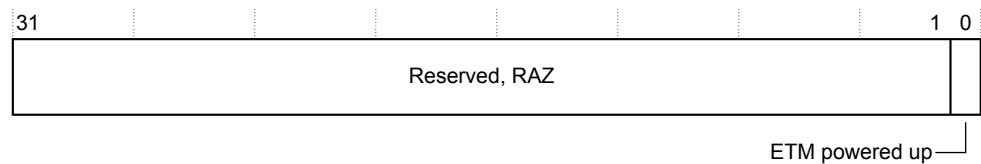

Figure 10-9 ETMPDSR bit assignments

Table 10-14 ETMPDSR bit assignments

Bits	Name	Function
[31:1]	-	Reserved, Read-As-Zero.
[0]	ETM powered up	The value of this bit indicates whether you can access the ETM Trace Registers. The value of this bit is always 1, indicating that the ETM Trace Registers can be accessed.

10.3.11 Integration Test Miscellaneous Inputs, ITMISCIN

Characteristics and bit assignments of the Integration Test Miscellaneous Inputs (ITMISCIN) register.

The ITMISCIN characteristics are:

Purpose

Integration test.

Usage constraints

There are no usage constraints.

Configurations

This register is only available if the processor is configured to use the ETM.

Attributes

Refer to the ETM register summary table.

ITMISCIN bit assignments are shown in the following figure and table.

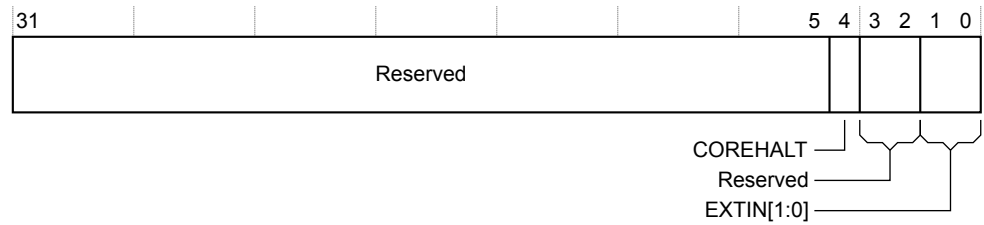

Figure 10-10 ITMISCIN bit assignments

Table 10-15 ITMISCIN bit assignments

Bits	Name	Function
[31:5]	-	Reserved.
[4]	COREHALT	A read of this bit returns the value of the COREHALT input pin.
[3:2]	-	Reserved.
[1:0]	EXTIN[1:0]	A read of these bits returns the value of the EXTIN[1:0] input pins.

10.3.12 Integration Test Trigger Out, ITTRIGOUT

Characteristics and bit assignments of the Integration Test Trigger Out (ITTRIGOUT) register.

The ITTRIGOUT characteristics are:

Purpose

Integration test.

Usage constraints

You must set bit [0] of ETMITCTRL to use this register.

Configurations

This register is only available if the processor is configured to use the ETM.

Attributes

Refer to the ETM register summary table.

ITTRIGOUT bit assignments are shown in the following figure and table.

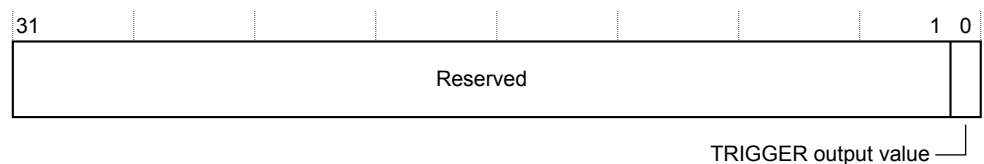

Figure 10-11 ITTRIGOUT bit assignments

Table 10-16 ITTRIGOUT bit assignments

Bits	Name	Function
[31:1]	-	Reserved
[0]	TRIGGER output value	A write to this bit sets the TRIGGER output.

10.3.13 ETM Integration Test ATB Control 2, ETM_ITATBCTR2

Characteristics and bit assignments of the ETM Integration Test ATB Control 2 (ETM_ITATBCTR2) register.

The ETM_ITATBCTR2 characteristics are:

Purpose

Integration test.

Usage constraints

You must set bit [0] of ETMITCTRL to use this register.

Configurations

This register is only available if the processor is configured to use the ETM.

Attributes

Refer to the ETM register summary table.

ETM_ITATBCTR2 bit assignments are shown in the following figure and table.

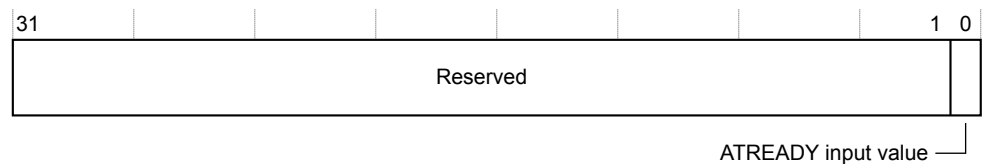

Figure 10-12 ETM_ITATBCTR2 bit assignments

Table 10-17 ETM_ITATBCTR2 bit assignments

Bits	Name	Function
[31:1]	-	Reserved
[0]	ATREADY input value	A read of this bit returns the value of the ETM ATREADY input.

10.3.14 ETM Integration Test ATB Control 0, ETM_ITATBCTR0

Characteristics and bit assignments of the Integration Test ATB Control (ETM_ITATBCTR0) register.

The ETM_ITATBCTR0 characteristics are:

Purpose

Integration test.

Usage constraints

You must set bit [0] of ETMITCTRL to use this register.

Configurations

This register is only available if the processor is configured to use the ETM.

Attributes

Refer to the ETM register summary table.

ETM_ITATBCTR0 bit assignments are shown in the following figure and table.

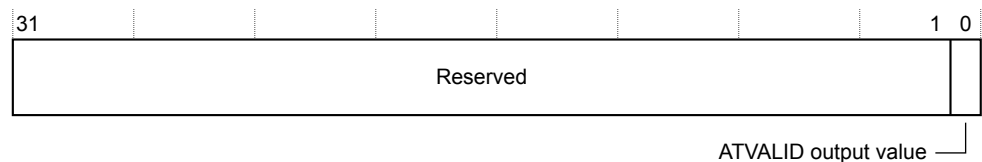

Figure 10-13 ETM_ITATBCTR0 bit assignments

Table 10-18 ETM_ITATBCTR0 bit assignments

Bits	Name	Function
[31:1]	-	Reserved
[0]	ATVALID output value	A write to this bit sets the value of the ETM ATVALID output.

Chapter 11

Trace Port Interface Unit

This chapter describes the Trace Port Interface Unit (TPIU) specific to this processor.

It contains the following sections:

- [11.1 About the TPIU on page 11-104.](#)
- [11.2 TPIU functional description on page 11-105.](#)
- [11.3 TPIU programmers model on page 11-107.](#)

11.1 About the TPIU

The Cortex-M3 TPIU is an optional component that acts as a bridge between the on-chip trace data from the Embedded Trace Macrocell (ETM) and the Instrumentation Trace Macrocell (ITM), with separate IDs, to a data stream. The TPIU encapsulates IDs where required, and the data stream is then captured by a Trace Port Analyzer (TPA).

The Cortex-M3 TPIU is specially designed for low-cost debug. It is a special version of the CoreSight TPIU. Your implementation can replace the Cortex-M3 TPIU with other CoreSight components if your implementation requires the additional features of the CoreSight TPIU.

In this chapter, the term TPIU refers to the Cortex-M3 TPIU. For information about the CoreSight TPIU, see the *ARM® CoreSight™ Components Technical Reference Manual*.

11.2 TPIU functional description

Functional description of the TPIU, including information on supported configurations and TPIU block diagrams.

This section contains the following subsections:

- [11.2.1 TPIU block diagram on page 11-105.](#)
- [11.2.2 TPIU formatter on page 11-105.](#)
- [11.2.3 Serial Wire Output format on page 11-105.](#)

11.2.1 TPIU block diagram

Block diagram showing the component layout of the TPIU.

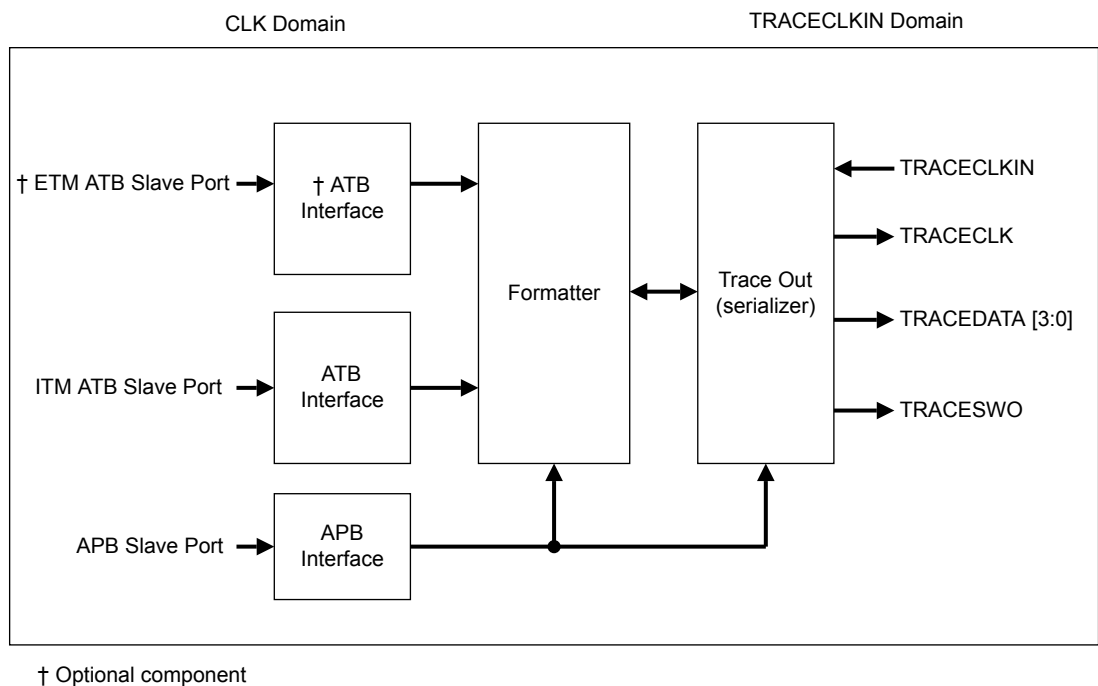

Figure 11-1 TPIU block diagram

11.2.2 TPIU formatter

The TPIU formatter inserts source ID signals into the data packet stream so that trace data can be re-associated with its trace source. The formatter is always active when the Trace Port Mode is active.

The formatting protocol is described in the *CoreSight™ Architecture Specification*. You must enable synchronization packets in the DWT to provide synchronization for the formatter.

When the formatter is enabled, half-sync packets can be inserted if there is no data to output after a frame has been started. Synchronization, caused by the distributed synchronization from the DWT, ensures that any partial frame is completed, and at least one full synchronization packet is generated.

11.2.3 Serial Wire Output format

The TPIU can output trace data in TPIU_DEVID or TPIU_SPPR Serial Wire Output formats and can be configured to bypass the formatter for trace output if either SWO format is selected.

The TPIU can output trace data in a *Serial Wire Output (SWO)* format:

- TPIU_DEVID specifies the formats that are supported.
- TPIU_SPPR specifies the SWO format in use. See the *ARM®v7-M Architecture Reference Manual*.

When one of the two SWO modes is selected, you can enable the TPIU to bypass the formatter for trace output. If the formatter is bypassed, only the ITM and DWT trace source passes through. The TPIU accepts and discards data from the ETM. This function can be used to connect a device containing an ETM to a trace capture device that is only able to capture SWO data.

11.3 TPIU programmers model

The TPIU registers table provides a summary of the TPIU registers. Depending on the implementation of your processor, the TPIU registers might not be present, or the CoreSight TPIU might be present instead. Any register that is configured as not present reads as zero.

Table 11-1 TPIU registers

Address	Name	Type	Reset	Description
0xE0040000	TPIU_SSPSR	RO	0x	Supported Parallel Port Size Register
0xE0040004	TPIU_CSPSR	RW	0x01	Current Parallel Port Size Register
0xE0040010	TPIU_ACPR	RW	0x0000	Asynchronous Clock Prescaler Register, TPIU_ACPR
0xE00400F0	TPIU_SPPR	RW	0x01	Selected Pin Protocol Register
0xE0040300	TPIU_FFSR	RO	0x08	Formatter and Flush Status Register, TPIU_FFSR
0xE0040304	TPIU_FFCR	RW	0x102	Formatter and Flush Control Register, TPIU_FFCR
0xE0040308	TPIU_FSCR	RO	0x00	Formatter Synchronization Counter Register
0xE0040EE8	TRIGGER	RO	0x0	TRIGGER
0xE0040EEC	FIFO data 0	RO	0x--000000	Integration ETM Data
0xE0040EF0	ITATBCTR2	RO	0x0	ITATBCTR2
0xE0040EFC	FIFO data 1	RO	0x--000000	Integration ITM Data
0xE0040EF8	ITATBCTR0	RO	0x0	ITATBCTR0
0xE0040F00	ITCTRL	RW	0x0	Integration Mode Control, TPIU_ITCTRL
0xE0040FA0	CLAIMSET	RW	0xF	Claim tag set
0xE0040FA4	CLAIMCLR	RW	0x0	Claim tag clear
0xE0040FC8	DEVID	RO	0xCA0/0xCA1	TPIU_DEVID
0xE0040FCC	DEVTYPE	RO	0x11	TPIU_DEVTYPE
0xE0040FD0	PID4	RO	0x04	Peripheral identification registers
0xE0040FD4	PID5	RO	0x00	
0xE0040FD8	PID6	RO	0x00	
0xE0040FDC	PID7	RO	0x00	
0xE0040FE0	PID0	RO	0x23	
0xE0040FE4	PID1	RO	0xB9	
0xE0040FE8	PID2	RO	0x3B	
0xE0040FEC	PID3	RO	0x00	Component identification registers
0xE0040FF0	CID0	RO	0x0D	
0xE0040FF4	CID1	RO	0x90	
0xE0040FF8	CID2	RO	0x05	
0xE0040FFC	CID3	RO	0xB1	

The following sections describe the TPIU registers whose implementation is specific to this processor. The Formatter, Integration Mode Control, and Claim Tag registers are described in the *CoreSight™*

Components Technical Reference Manual. Other registers are described in the *ARMv7-M Architecture Reference Manual*.

This section contains the following subsections:

- [11.3.1 Asynchronous Clock Prescaler Register, TPIU_ACPR](#) on page 11-108.
- [11.3.2 Formatter and Flush Status Register, TPIU_FFSR](#) on page 11-108.
- [11.3.3 Formatter and Flush Control Register, TPIU_FFCR](#) on page 11-109.
- [11.3.4 TRIGGER](#) on page 11-110.
- [11.3.5 Integration ETM Data](#) on page 11-111.
- [11.3.6 ITATBCTR2](#) on page 11-111.
- [11.3.7 Integration ITM Data](#) on page 11-112.
- [11.3.8 ITATBCTR0](#) on page 11-113.
- [11.3.9 Integration Mode Control, TPIU_ITCTRL](#) on page 11-113.
- [11.3.10 TPIU_DEVID](#) on page 11-114.
- [11.3.11 TPIU_DEVTYPE](#) on page 11-115.

11.3.1 Asynchronous Clock Prescaler Register, TPIU_ACPR

Characteristics and bit assignments of the TPIU_ACPR register.

Purpose

Scales the baud rate of the asynchronous output.

Usage constraints

There are no usage constraints.

Configurations

This register is available in all processor configurations.

Attributes

Refer to the TPIU register table.

The following figure shows the TPIU_ACPR bit assignments.



Figure 11-2 TPIU_ACPR bit assignments

The following table shows the TPIU_ACPR bit assignments.

Table 11-2 TPIU_ACPR bit assignments

Bits	Name	Function
[31:13]	-	Reserved. RAZ/SBZP.
[12:0]	PRESCALER	Divisor for TRACECLKIN is Prescaler + 1.

11.3.2 Formatter and Flush Status Register, TPIU_FFSR

Characteristics and bit assignments of the TPIU_FFSR register.

Purpose

Indicates the status of the TPIU formatter.

Usage constraints

There are no usage constraints.

Configurations

This register is available in all processor configurations.

Attributes

Refer to the TPIU register table.

The following figure shows the TPIU_FFSR bit assignments.

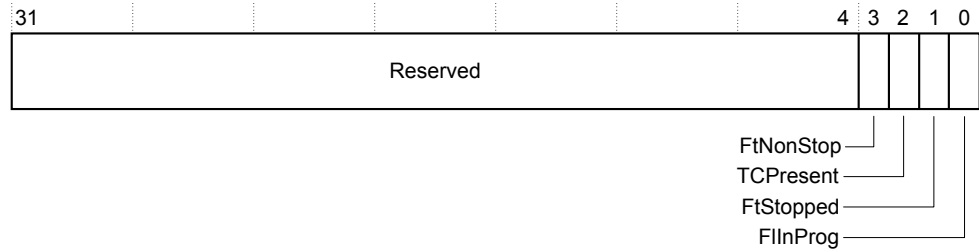

Figure 11-3 TPIU_FFSR bit assignments

The following table shows the TPIU_FFSR bit assignments.

Table 11-3 TPIU_FFSR bit assignments

Bits	Name	Function
[31:4]	-	Reserved
[3]	FtNonStop	Formatter cannot be stopped
[2]	TCPresent	This bit always reads zero
[1]	FtStopped	This bit always reads zero
[0]	FIInProg	This bit always reads zero

11.3.3 Formatter and Flush Control Register, TPIU_FFCR

Characteristics and bit assignments of the TPIU_FFCR register.

Purpose

Controls the TPIU formatter.

Usage constraints

There are no usage constraints.

Configurations

This register is available in all processor configurations.

Attributes

Refer to the TPIU register table.

The following figure shows the TPIU_FFCR bit assignments.

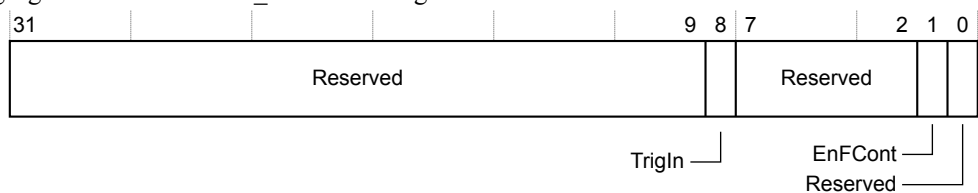

Figure 11-4 TPIU_FFCR bit assignments

The following table shows the TPIU_FFCR bit assignments.

Table 11-4 TPIU_FFCR bit assignments

Bits	Name	Function
[31:9]	-	Reserved.
[8]	TrigIn	This bit Reads-As-One (RAO), specifying that triggers are inserted when a trigger pin is asserted.
[7:2]	-	Reserved.

Table 11-4 TPIU_FFCR bit assignments (continued)

Bits	Name	Function
[1]	EnFCont	Enable continuous formatting. Value can be: 0 = Continuous formatting disabled. 1 = Continuous formatting enabled.
[0]	-	Reserved.

The TPIU can output trace data in a *Serial Wire Output* (SWO) format.

When one of the two SWO modes is selected, bit [1] of TPIU_FFCR enables the formatter to be bypassed. If the formatter is bypassed, only the ITM and DWT trace source passes through. The TPIU accepts and discards data from the ETM. This function can be used to connect a device containing an ETM to a trace capture device that is only able to capture SWO data. Enabling or disabling the formatter causes momentary data corruption.

Note

If TPIU_SPPR is set to select Parallel Port Mode, the formatter is automatically enabled. If you then select one of the SWO modes, TPIU_FFCR reverts to its previously programmed value.

Related concepts

Serial Wire Output format.

11.3.4 TRIGGER

Characteristics and bit assignments of the TRIGGER.

Purpose

Integration test of the TRIGGER input.

Usage constraints

There are no usage constraints.

Configurations

This register is available in all processor configurations.

Attributes

Refer to the TPIU register table.

The following figure shows the TRIGGER bit assignments.

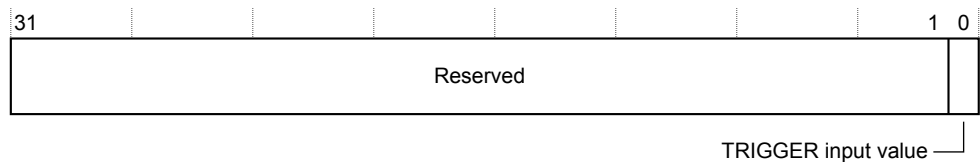

Figure 11-5 TRIGGER bit assignments

The following table shows the TRIGGER bit assignments.

Table 11-5 TRIGGER bit assignments

Bits	Name	Function
[31:1]	-	Reserved
[0]	TRIGGER input value	When read, this bit returns the TRIGGER input.

11.3.5 Integration ETM Data

Characteristics and bit assignments of the Integration ETM Data register.

Purpose

Trace data integration testing.

Usage constraints

You must set bit [1] of TPIU_ITCTRL to use this register.

Configurations

This register is available in all processor configurations.

Attributes

Refer to the TPIU register table.

The following figure shows the Integration ETM Data bit assignments.

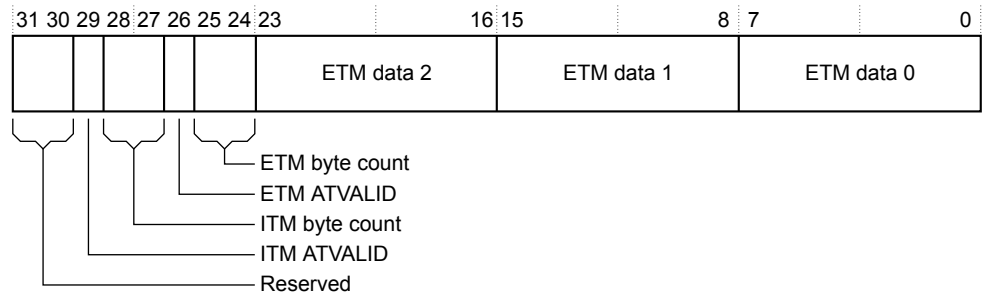

Figure 11-6 Integration ETM Data bit assignments

The following table shows the Integration ETM Data bit assignments.

Table 11-6 Integration ETM Data bit assignments

Bits	Name	Function
[31:30]	-	Reserved
[29]	ITM ATVALID input	Returns the value of the ITM ATVALID signal.
[28:27]	ITM byte count	Number of bytes of ITM trace data since last read of Integration ITM Data Register.
[26]	ETM ATVALID input	Returns the value of the ETM ATVALID signal.
[25:24]	ETM byte count	Number of bytes of ETM trace data since last read of Integration ETM Data Register.
[23:16]	ETM data 2	ETM trace data. The TPIU discards this data when the register is read.
[15:8]	ETM data 1	
[7:0]	ETM data 0	

11.3.6 ITATBCTR2

Characteristics and bit assignments of the ITATBCTR2 register.

Purpose

Integration test.

Usage constraints

You must set bit [0] of TPIU_ITCTRL to use this register.

Configurations

This register is available in all processor configurations.

Attributes

Refer to the TPIU register table.

The following figure shows the ITATBCTR2 bit assignments.

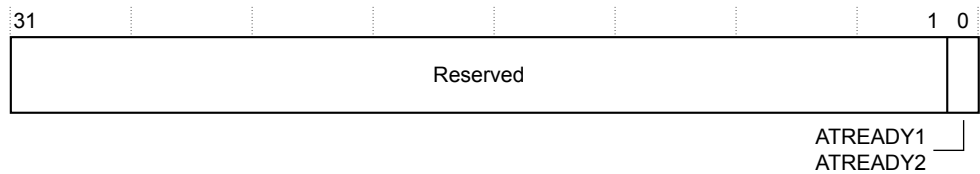

Figure 11-7 ITATBCTR2 bit assignments

The following table shows the ITATBCTR2 bit assignments.

Table 11-7 ITATBCTR2 bit assignments

Bits	Name	Function
[31:1]	-	Reserved
[0]	ATREADY1, ATREADY2	This bit sets the value of both the ETM and ITM ATREADY outputs, if the TPIU is in integration test mode.

11.3.7 Integration ITM Data

Characteristics and bit assignments of the Integration ITM Data register.

Purpose

Trace data integration testing.

Usage constraints

You must set bit [1] of TPIU_ITCTRL to use this register.

Configurations

This register is available in all processor configurations.

Attributes

Refer to the TPIU register table.

The following figure shows the Integration ITM Data bit assignments.

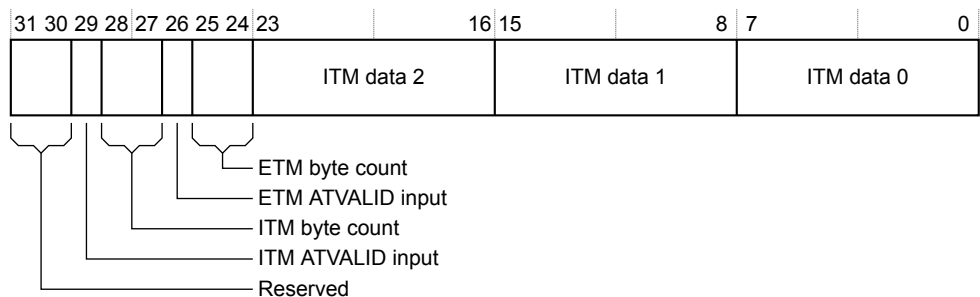

Figure 11-8 Integration ITM Data bit assignments

The following table shows the Integration ITM Data bit assignments.

Table 11-8 Integration ITM Data bit assignments

Bits	Name	Function
[31:30]	-	Reserved
[29]	ITM ATVALID input	Returns the value of the ITM ATVALID signal.
[28:27]	ITM byte count	Number of bytes of ITM trace data since last read of Integration ITM Data Register.
[26]	ETM ATVALID input	Returns the value of the ETM ATVALID signal.
[25:24]	ETM byte count	Number of bytes of ETM trace data since last read of Integration ETM Data Register.

Table 11-8 Integration ITM Data bit assignments (continued)

Bits	Name	Function
[23:16]	ITM data 2	ITM trace data. The TPIU discards this data when the register is read.
[15:8]	ITM data 1	
[7:0]	ITM data 0	

11.3.8 ITATBCTR0

Characteristics and bit assignments of the ITATBCTR0 register.

Purpose

Integration test.

Usage constraints

There are no usage constraints.

Configurations

This register is available in all processor configurations.

Attributes

Refer to the TPIU register table.

The following figure shows the ITATBCTR0 bit assignments.

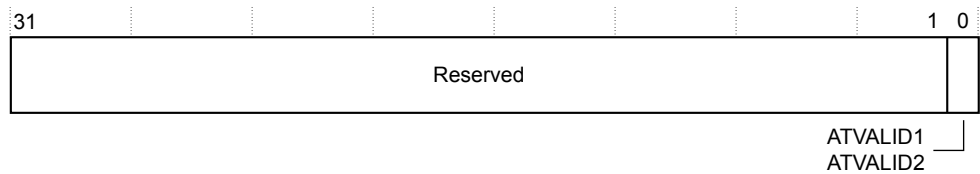

Figure 11-9 ITATBCTR0 bit assignments

The following table shows the ITATBCTR0 bit assignments.

Table 11-9 ITATBCTR0 bit assignments

Bits	Name	Function
[31:1]	-	Reserved
[0]	ATVALID1, ATVALID2	A read of this bit returns the value of ATVALID1 OR-ed with ATVALID2.

11.3.9 Integration Mode Control, TPIU_ITCTRL

Characteristics and bit assignments of the TPIU_ITCTRL register.

Purpose

Specifies normal or integration mode for the TPIU.

Usage constraints

There are no usage constraints.

Configurations

This register is available in all processor configurations.

Attributes

Refer to the TPIU register table.

The following figure shows the TPIU_ITCTRL bit assignments.

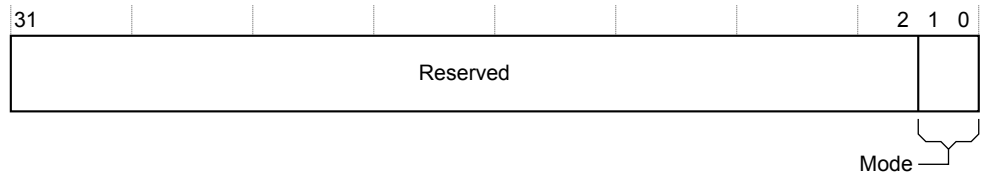

Figure 11-10 TPIU_ITCTRL bit assignments

The following table shows the TPIU_ITCTRL bit assignments.

Table 11-10 TPIU_ITCTRL bit assignments

Bits	Name	Function
[31:2]	-	Reserved.
[1:0]	Mode	Specifies the current mode for the TPIU:
	b00	Normal mode.
	b01	Integration test mode.
	b10	Integration data test mode.
	b11	Reserved.

In integration data test mode, the trace output is disabled, and data can be read directly from each input port using the integration data registers.

11.3.10 TPIU_DEVID

Characteristics and bit assignments of the TPIU_DEVID.

The TPIU_DEVID characteristics are:

Purpose

Indicates the functions provided by the TPIU for use in topology detection.

Usage constraints

There are no usage constraints.

Configurations

This register is available in all processor configurations.

Attributes

Refer to the TPIU registers table.

The following figure shows the TPIU_DEVID bit assignments.

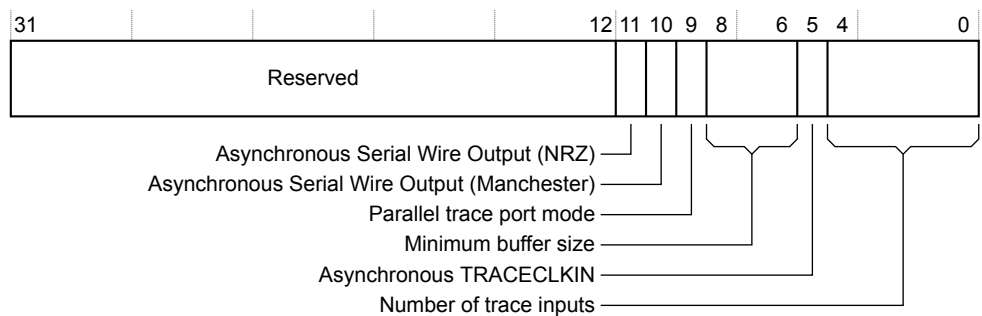

Figure 11-11 TPIU_DEVID bit assignments

The following table shows the TPIU_DEVID bit assignments.

Table 11-11 TPIU_DEVID bit assignments

Bits	Name	Function
[31:12]	-	Reserved
[11]	Asynchronous Serial Wire Output (NRZ)	This bit Reads-As-One (RAO), indicating that the output is supported.
[10]	Asynchronous Serial Wire Output (Manchester)	This bit Reads-As-One (RAO), indicating that the output is supported.
[9]	Parallel trace port mode	This bit Reads-As-Zero (RAZ), indicating that parallel trace port mode is supported.
[8:6]	Minimum buffer size	Specifies the minimum TPIU buffer size: 0b010 = 4 bytes.
[5]	Asynchronous TRACECLKIN	Specifies whether TRACECLKIN can be asynchronous to CLK : 0b1 = TRACECLKIN can be asynchronous to CLK .
[4:0]	Number of trace inputs	Specifies the number of trace inputs: 0b00000 = 1 input 0b00001 = 2 inputs If your implementation includes an ETM, the value of this field is 0b00001 .

11.3.11 TPIU_DEVTYPE

The Device Type Identifier Register is read-only. It provides a debugger with information about the component when the Part Number field is not recognized. The debugger can then report this information.

The TPIU_DEVTYPE characteristics are:

Purpose

Indicates the type of functionality the component supports.

Usage Constraints

There are no usage constraints.

Configurations

This register is available in all processor configurations.

Attributes

The Device Type reads as 0x11 and indicates this device is a trace sink and specifically a TPIU.

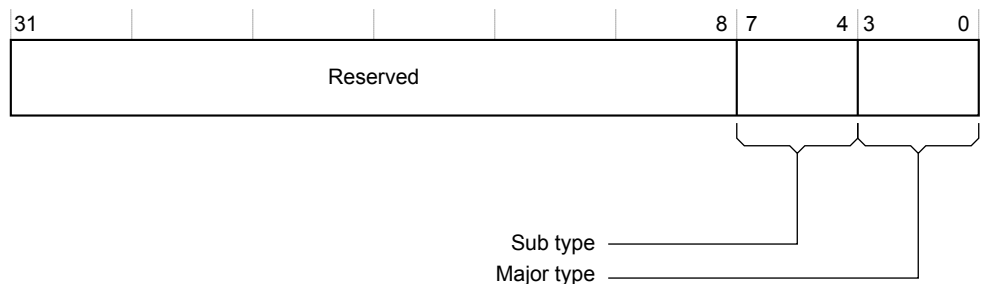

Figure 11-12 TPIU_DEVTYPE bit assignments

Appendix A

Revisions

The technical changes between released issues of this book.

It contains the following sections:

- [A.1 Revisions on page Appx-A-117.](#)

A.1 Revisions

This appendix describes the technical changes between released issues of this book.

Table A-1 Differences between issue E and issue F

Change	Location
Introductory processor information updated	Issue H distributes this information between <i>1.1 About the processor</i> on page 1-12 and <i>1.2 Processor features list</i> on page 1-13 and removes duplicate information from these sections.
Processor block diagram updated	<i>2.1 About the functions</i> on page 2-22
Introductory information added, including: <ul style="list-style-type: none"> • TPIU subsection. • Addition of note to SW/SWJ-DP subsection. • ROM table subsection. 	Issue H removes this information.
Introductory processor core information updated	
APB bus now version 3.0	<i>1.5.3 Architecture and protocol information</i> on page 1-18
Configurable options information expanded to include: <ul style="list-style-type: none"> • Added DWT configurability information. • New subsections for ITM, AHB-AP, FPB and Observation. 	<i>1.4 Optional implementation components</i> on page 1-15
New subsection added to list changes in functionality between r1p1 and r2p0	<i>1.6.3 List of differences in functionality between r1p1 and r2p0</i> on page 1-19
Information about the programmers model updated	Issue H distributes this information between <i>1.1 About the processor</i> on page 1-12 and <i>3.2 Modes of operation and execution</i> on page 3-30.
Definition of ICI field of Execution Program Status Register updated	Issue H removes this information.
Table of nonsupported Thumb instructions removed.	
Second footnote on Table 5-1 removed.	Issue H removes this information.
Addition of note to vector table and reset description	
Description of SLEEPING and SLEEPDEEP signals updated.	
Description of extending sleep functionality added	
Addition of Auxiliary Control Register	<i>Auxiliary Control Register, ACTLR</i>
Irq 0 to 31 Priority Register amended to Irq 0 to 3 Priority Register	Issue H removes this information.
Irq 236 to 239 Priority Register amended to Irq 224 to 239 Priority Register	
HCLK changed to FCLK	
Addition of ascending MPU region priority information	<i>5.1 About the MPU</i> on page 5-55
Extra paragraph added.	Issue H removes this information.
Debug Core Register Selector Register REGSEL bit field function updated	
Paragraph added about removing FPB	

Table A-1 Differences between issue E and issue F (continued)

Change	Location
Addition of note about configuring flash patch registers to be present or not	7.3.3 FPB programmers' model on page 7-71
First bullet point updated	8.1 DWT functional description on page 8-73
Addition of note about configuring DWT registers to be present or not	8.2 DWT Programmers' model on page 8-74
DWT Control Register reset state updated	8.2 DWT Programmers' model on page 8-74
DWT Control Register bit assignments updated	Issue H removes this information.
Addition of note about configuring ITM registers to be present or not	7.3.3 FPB programmers' model on page 7-71
ITM Trace Control Register TSENA field bit function updated	
Addition of note about configuring AHB-AP registers to be present or not	7.3.3 FPB programmers' model on page 7-71
AHB-AP Banked Data Register DATA field reset value removed	Issue H removes this information.
Addition of information about absence of debug functionality	7.1 Debug configuration on page 7-63
Information about exclusive memory accesses updated	Issue H removes this information.
Note about bit-band accesses updated	3.7 Bit-banding on page 3-42
ETM block diagram updated	10.2.1 ETM block diagram on page 10-82
HCLK and CLK replaced by FCLK	Issue H removes this information.
ETM Trigger Even Register description upgraded	
ETM Status Register description updated	
TraceEnable register replaced by Trace Start/Stop Resource Control	
TraceEnable Control 2 register added	
Lock Status Register added	
Description of FIFOFULL Region Register added	
Description of FIFOFULL Level Register updated	
Description of CoreSight Trace ID Register updated	
Description ETM Control Register implementation bits expanded	10.3.3 Main Control Register, ETMCR on page 10-90
Description of TraceEnable Control 1 Register updated	10.3.6 TraceEnable Control 1 Register, ETMTECRI characteristics on page 10-95
Description ETM ID Register updated to reflect revision 2	10.3.7 ID Register, ETMIDR characteristics on page 10-95
Subsection describing ETM Event Resources added	10.2.3 Resources on page 10-83
Subsection describing Cross Trigger Interface added	Table of recommended CTI connections on page 10-86
Branch status interface section updated	Issue H removes this information.
Note about HADDRICore and HTRANSICore removed	
Example of an opcode sequence timing diagram updated	
Description of APB interface inputs added	
Addition of note about configuring TPIU registers to be present or not	11.3 TPIU programmers model on page 11-107

Table A-1 Differences between issue E and issue F (continued)

Change	Location
The following TPIU registers removed from summary table and descriptions: <ul style="list-style-type: none"> • Trigger control registers. • EXTCTL port registers. • Test pattern registers. 	Issue H removes this information.
The following TPIU registers added to the summary table and descriptions: <ul style="list-style-type: none"> • Integration Register: TRIGGER. • Integration Mode Control Register. • Integration Register: FIFO data 0. • Integration Register: FIFO data 1. • Claim tag set register. • Claim tag clear register. • Device ID register. • PID registers. • CID registers. 	

Table A-2 Differences between issue F and issue G

Change	Location
<i>Wake-up Interrupt Controller (WIC)</i> added to Cortex-M3 block diagram	<i>2.1 About the functions</i> on page 2-22
Section 1-2 and section 1-3 combined	Issue H distributes this information between <i>1.2 Processor features list</i> on page 1-13, <i>1.2 Processor features list</i> on page 1-13, and <i>1.4 Optional implementation components</i> on page 1-15.
New subsection added to list changes in functionality between r1p1 and r2p0	<i>1.6.3 List of differences in functionality between r1p1 and r2p0</i> on page 1-19
New subsection added to describe the WIC	<i>6.1.2 Low power modes</i> on page 6-59
New bullet point to describe FIXHMASTERTYPE pin	<i>1.6.3 List of differences in functionality between r1p1 and r2p0</i> on page 1-19
Table of supported instruction removed	Issue H reinstates this information in <i>Table of the processor instruction set summary</i> .

Table A-2 Differences between issue F and issue G (continued)

Change	Location
More information added about the stacked xPSR	Issue H removes this information.
Reset value of Configuration Control Register changed to 0x00000200	
System and Vendor_SYS memory regions added to table of memory region permissions	
Memory region for Private Peripheral Bus changed to +0000000	
SLEEPHOLDREQ changed to SLEEPHOLDREQn	
SLEEPHOLDACK changed to SLEEPHOLDACKn	
DEEPSLEEP signal changed to SLEEPDEEP	
DBGRESTARTACK changed to DBGRESTARTED	
DBGRESTARTREQ changed to DBGRESTART	
New subsection added to describe the WIC	
Address of Irq 224 to 239 Priority Register changed to 0xE00E4EC	
Enhanced description of function of C_MASKINTS field	
Settings for DWT Function Registers updated	
Minor change to timing information of ETMIA	
Change to timing information for ETMIVALID	Issue H removes this information.
SLEEPHOLDREQn removed from table of miscellaneous input ports timing parameters	
Table of low power input ports timing parameters added	
FIXHMASTERTYPE added to table of debug input ports timing parameters	
Input changed to Output in table header	
SLEEPING , SLEEPDEEP , and SLEEPHOLDACKn removed from table of miscellaneous output ports timing parameters	
SLEEPDEEP , SLEEPING , SLEEPHOLDREQ , and SLEEPHOLDACK removed	
New section added to describe the low power interface signals	
New section added to describe the WIC interface signals	
SLEEPHOLDACKn removed from table of miscellaneous signals	
Asserted changed to de-asserted in the description of SLEEPHOLDREQn in table of low power interface signals	
FIXMASTERTPYE added to list of AHB-AP interface signals	

Note

Issue H of this book is significantly reorganized and simplified to eliminate duplication of information contained in the ARM Architecture Reference Manual and other ARM documentation.

Table A-3 Differences between issue G and issue H

Change	Location
Chapter 1 simplified to provide only a high-level description of the processor. Some information to Chapter 2.	<i>Chapter 1 Introduction</i> on page 1-11 <i>Chapter 2 Functional Description</i> on page 2-21
Removed the following sections from Chapter 1: <ul style="list-style-type: none"> • Execution pipeline stages. • Prefetch unit. • Branch target forwarding. • Store buffers. 	See the <i>ARMv7-M Architecture Reference Manual</i> and the implementation documentation for the processor.
Added functional description chapter	<i>Chapter 2 Functional Description</i> on page 2-21
Simplified description of the programmers model and modes of operation and execution	<i>3.1 About the programmers' model</i> on page 3-29 <i>3.2 Modes of operation and execution</i> on page 3-30
Added cycle counts to instruction set summary	<i>3.3 Instruction set summary</i> on page 3-31
Descriptions of the memory system and of exceptions moved to Chapter 3.	<i>Chapter 3 Programmers Model</i> on page 3-28
Component-specific registers moved from System Control chapter to appropriate chapters within the manual.	<i>Chapter 4 System Control</i> on page 4-48
Deleted Clocking and Resets chapter.	See the implementation documentation for the processor.
Deleted Power Management chapter.	
In the Memory Protection Unit and Nested Vector Interrupt Controller chapters, removed description of architecturally-defined registers.	
Reorganized debug description into a single chapter.	<i>Chapter 7 Debug</i> on page 7-62
Deleted Bus Interface chapter and moved high-level information to appropriate chapters.	<i>Chapter 1 Introduction</i> on page 1-11 <i>Chapter 2 Functional Description</i> on page 2-21 <i>Chapter 3 Programmers Model</i> on page 3-28
Deleted Debug Port chapter and incorporated general information from this chapter into chapters 2 and 7.	<i>Chapter 2 Functional Description</i> on page 2-21 <i>Chapter 7 Debug</i> on page 7-62
Moved information from the System Debug chapter to create new chapters for the Data Watchpoint and Trace Unit and the Instrumentation Trace Macrocell Unit.	<i>Chapter 8 Data Watchpoint and Trace Unit</i> on page 8-72 <i>Chapter 9 Instrumentation Trace Macrocell Unit</i> on page 9-76
Reorganized Embedded Trace Macrocell description into a single chapter.	<i>Chapter 10 Embedded Trace Macrocell</i> on page 10-80
Removed signal information and architecturally-defined register descriptions from the Trace Port Interface Unit chapter.	Removed duplicate information. See the <i>ARMv7-M Architecture Reference Manual</i> and the implementation documentation for the processor.
Moved instruction timing information to chapter 3.	<i>3.3 Instruction set summary</i> on page 3-31
Removed AC Characteristics and Signal Descriptions chapters.	See the implementation documentation for the processor.

Table A-4 Differences between issue H and issue I

Change	Location
Updated Bus interfaces information.	<i>2.3.1 Bus interfaces on page 2-25</i>
Added information on Private Peripheral Bus	<i>Private Peripheral Bus (PPB) on page 2-26</i>
Updated Load/store timings information.	<i>3.3.2 Load/store timings on page 3-35</i>
Updated Exclusive monitor information.	<i>3.6 Exclusive monitor on page 3-41</i>
Updated Reset values for Register summary information.	<i>4.1 System control registers on page 4-49</i>
Reset values updated.	<i>4.1 System control registers on page 4-49</i>
Updated Reset values for MPU register information.	<i>5.3 MPU programmers model table on page 5-57</i>
Changed address range of NVIC_IPR registers.	<i>6.2.1 Table of NVIC registers on page 6-60</i>
Updated values for the Cortex-M3 ROM table information and added Peripheral IDs 5-7.	<i>ROM table identification and entries</i>
Added Timestamp format information.	<i>10.2.4 Timestamp format on page 10-85</i>
Added ETM register descriptions.	<i>10.3.2 ETM register summary table on page 10-88</i>
Added ETMCNTRLDVR1 ETM register.	<i>10.3.2 ETM register summary table on page 10-88</i>
Changed reset values for ETMVCCR and ETMCCER.	<i>10.3.2 ETM register summary table on page 10-88</i>
Updated ETMCR register bit assignments.	<i>10.3.3 Main Control Register, ETMCR on page 10-90</i>
Updated ETMCCR bit assignments.	<i>10.3.4 Configuration Code Register, ETMCCR on page 10-93</i>
Updated ETMCCER bit assignments.	<i>10.3.8 Configuration Code Extension Register, ETMCCER characteristics on page 10-96</i>
Added TPIU_DEVTYPE TPIU Register. Changed reset values.	<i>11.3 TPIU programmers model on page 11-107</i>
Updated TPIU Formatter information	<i>11.2.2 TPIU formatter on page 11-105</i>
Replaced FIFO 0 with ETM.	<i>Integration ETM Data</i> <i>Integration ITM Data</i>
Replaced FIFO 1 with ITM	<i>Integration ETM Data</i> <i>Integration ITM Data</i>
Added TPIU_DEVTYPE Register description.	<i>11.3 TPIU programmers model on page 11-107</i>