

Analyzer Tile

HBI-0114

User Guide

ARM[®]

Analyzer Tile

User Guide

Copyright © 2003-2011. ARM Limited. All rights reserved.

Release Information

The following changes have been made to this book.

Change History

Date	Issue	Confidential	Change
15 October 2003	A	Non-Confidential	New document
20 April 2011	B	Non-Confidential	Updated to amend tables in appendix A

Proprietary Notice

Words and logos marked with [™] or [®] are registered trademarks or trademarks of ARM[®] Limited in the EU and other countries, except as otherwise stated below in this proprietary notice. Other brands and names mentioned herein may be the trademarks of their respective owners.

Neither the whole nor any part of the information contained in, or the product described in, this document may be adapted or reproduced in any material form except with the prior written permission of the copyright holder.

The product described in this document is subject to continuous developments and improvements. All particulars of the product and its use contained in this document are given by ARM in good faith. However, all warranties implied or expressed, including but not limited to implied warranties of merchantability, or fitness for purpose, are excluded.

This document is intended only to assist the reader in the use of the product. ARM Limited shall not be liable for any loss or damage arising from the use of any information in this document, or any error or omission in such information, or any incorrect use of the product.

Where the term ARM is used it means “ARM or any of its subsidiaries as appropriate”.

Confidentiality Status

This document is Non-Confidential. The right to use, copy and disclose this document may be subject to license restrictions in accordance with the terms of the agreement entered into by ARM and the party that ARM delivered this document to.

Product Status

The information in this document is final, that is for a developed product.

Web Address

<http://www.arm.com>

Contents

Analyzer Tile User Guide

	Preface	
	About this document	x
	Further reading	xii
	Feedback	xiii
Chapter 1	Introduction	
	1.1 About the Analyzer Tile	1-2
	1.2 Analyzer Tile layout	1-3
Chapter 2	Using the Analyzer Tile	
	2.1 Connecting the Analyzer Tile	2-2
	2.2 Mictor connectors	2-4
	2.3 Signal description	2-7
Appendix A	Pinouts and Specifications	
	A.1 Test points	A-2
	A.2 Logic analyzer connectors	A-4
	A.3 Tile connections	A-24
	A.4 Electrical specification	A-39
	A.5 Mechanical specification	A-40

List of Tables

Analyzer Tile User Guide

	Change History	ii
Table 2-1	Agilent logic analyzer probe	2-5
Table 2-2	Tektronix logic analyzer probe	2-6
Table 2-3	Connector summary	2-7
Table A-1	Test connections	A-3
Table A-2	Mictor connector J7, X31-X0	A-4
Table A-3	Mictor connector J8, X63-X32	A-5
Table A-4	Mictor connector J9, X95-X64	A-6
Table A-5	Mictor connector J10, X127-X96	A-7
Table A-6	Mictor connector J11, X159-X128	A-8
Table A-7	Mictor connector J12, JTAG and X179-X160	A-9
Table A-8	Mictor connector J13, Y31-Y0	A-10
Table A-9	Mictor connector J14, Y63-Y32	A-11
Table A-10	Mictor connector J15, Y95-Y64	A-12
Table A-11	Mictor connector J16, Y127-Y96	A-13
Table A-12	Mictor connector J17, SPARE and Y152-Y132	A-14
Table A-13	Mictor connector J18, JTAG and Y179-Y153	A-15
Table A-14	Mictor connector J19, Z31-Z0	A-16
Table A-15	Mictor connector J20, Z63-Z32	A-17
Table A-16	Mictor connector J21, Z95-Z64	A-18
Table A-17	Mictor connector J22, Z191-Z160	A-19
Table A-18	Mictor connector J23, Z159-Z128	A-20
Table A-19	Mictor connector J24, Z255-Z224	A-21

List of Tables

Table A-20	Mictor connector J25, Z223-Z192	A-22
Table A-21	Mictor connector J26, Z127-Z96	A-23
Table A-22	HDRX signals	A-24
Table A-23	HDRY signals	A-28
Table A-24	HDRZ signals	A-32
Table A-25	Electrical characteristics for 3.3V I/O	A-39
Table A-26	Current requirements	A-39

List of Figures

Analyzer Tile User Guide

Figure 1-1	Analyzer Tile layout	1-3
Figure 2-1	Interface Tile mounted on logic tile and interface module	2-2
Figure 2-2	Logic Tile signals	2-3
Figure 2-3	AMP Mictor connector	2-4
Figure 2-4	HDRZ clock signals	2-9
Figure A-1	Test points	A-2
Figure A-2	Analyzer Tile measurements	A-40

Preface

This preface introduces the documentation for the Analyzer Tile. It contains the following sections::

- *About this document* on page x
- *Further reading* on page xii
- *Feedback* on page xiii.

About this document

This document describes how to set up and use the Analyzer Tile.

Intended audience

This document has been written for experienced hardware and software developers as an aid to using the Analyzer Tile with the RealView Logic Tiles.

Organization

This document is organized into the following chapters:

Chapter 1 *Introduction*

Read this chapter for an introduction to the Analyzer Tile.

Chapter 2 *Using the Analyzer Tile*

Read this chapter for a description of how to set up and start using the Analyzer Tile.

Appendix A *Pinouts and Specifications*

Read this chapter for information about the signals on the Mictor, tile, and testpoint connectors and the mechanical and electrical specifications for the Analyzer Tile.

Typographical conventions

The following typographical conventions are used in this book:

- `monospace` Denotes text that can be entered at the keyboard, such as commands, file and program names, and source code.
- monospace Denotes a permitted abbreviation for a command or option. The underlined text can be entered instead of the full command or option name.
- monospace italic* Denotes arguments to commands and functions where the argument is to be replaced by a specific value.
- italic* Highlights important notes, introduces special terminology, denotes internal cross-references, and citations.
- bold** Highlights interface elements, such as menu names and buttons. Also used for terms in descriptive lists, where appropriate.
- `monospace bold` Denotes language keywords when used outside example code and ARM processor signal names.

Further reading

This section lists related publications by ARM Limited and other companies provide additional information.

ARM publications

The following publications provide information about related ARM products and toolkits:

- ARM RealView/XC2V4000+ Logic Tile User Guide (ARM DUI 00186)
- ARM Integrator/IM-LT1 Interface Module User Guide (ARM DUI 00187)
- ARM Integrator/AP User Guide (ARM DUI 0098)
- ARM Integrator/CP User Guide (ARM DUI 0159)
- ARM RealView ICE User Guide (ARM DUI 0155)
- ARM Multi-ICE User Guide (ARM DUI 0048)
- ADS Developer Guide (ARM DUI 0056)
- RealView Compilation Tools Developer Guide (ARM DUI 0203).

Feedback

ARM Limited welcomes feedback both on the Analyzer Tile and on the documentation.

Feedback on this document

If you have any comments about this document, please send email to errata@arm.com giving:

- the document title
- the document number
- the page number(s) to which your comments refer
- an explanation of your comments.

General suggestions for additions and improvements are also welcome.

Feedback on the Analyzer Tile

If you have any comments or suggestions about this product, please contact your supplier giving:

- the product name
- an explanation of your comments.

Chapter 1

Introduction

This chapter introduces the Analyzer Tile. It contains the following sections:

- *About the Analyzer Tile* on page 1-2
- *Analyzer Tile layout* on page 1-3.

1.1 About the Analyzer Tile

The Analyzer Tile provides access to the signals present on headers HDRX, HDY, and HDRZ of RealView Logic Tiles. The Analyzer Tile can be inserted between tiles, as shown in Figure 1-1 on page 1-3, or it can be used on the top of a stack of Logic Tiles. The Analyzer Tile can be used with individual Logic Tiles or Logic Tiles mounted on a development board, for example, the Versatile Platform Baseboard for ARM926EJ-S.

———— **Note** —————

Integrator development boards, such as the Integrator/AP, do not have tile headers so an Integrator/IM-LT1 Interface Module must be used between the Integrator board and a Logic Tile. Because of the component height on the Integrator/IM-LT1 Interface Module, the Analyzer Tile cannot be used directly on top of an Interface Module.

A Logic Tile does not have a fixed bus structure, but an AMBA bus is often implemented for communication between the tiles and baseboard.

The logic analyzer connection points are AMP Mictor connectors (AMP 2-767004-2), which are specified by both Agilent and Tektronix as suitable for connection to a range of logic analyzers. The Mictor connectors are mounted on the top of the Analyzer Tile and permit you to connect flying leads and test equipment.

1.2 Analyzer Tile layout

Figure 1-1 shows the layout of the Analyzer Tile.

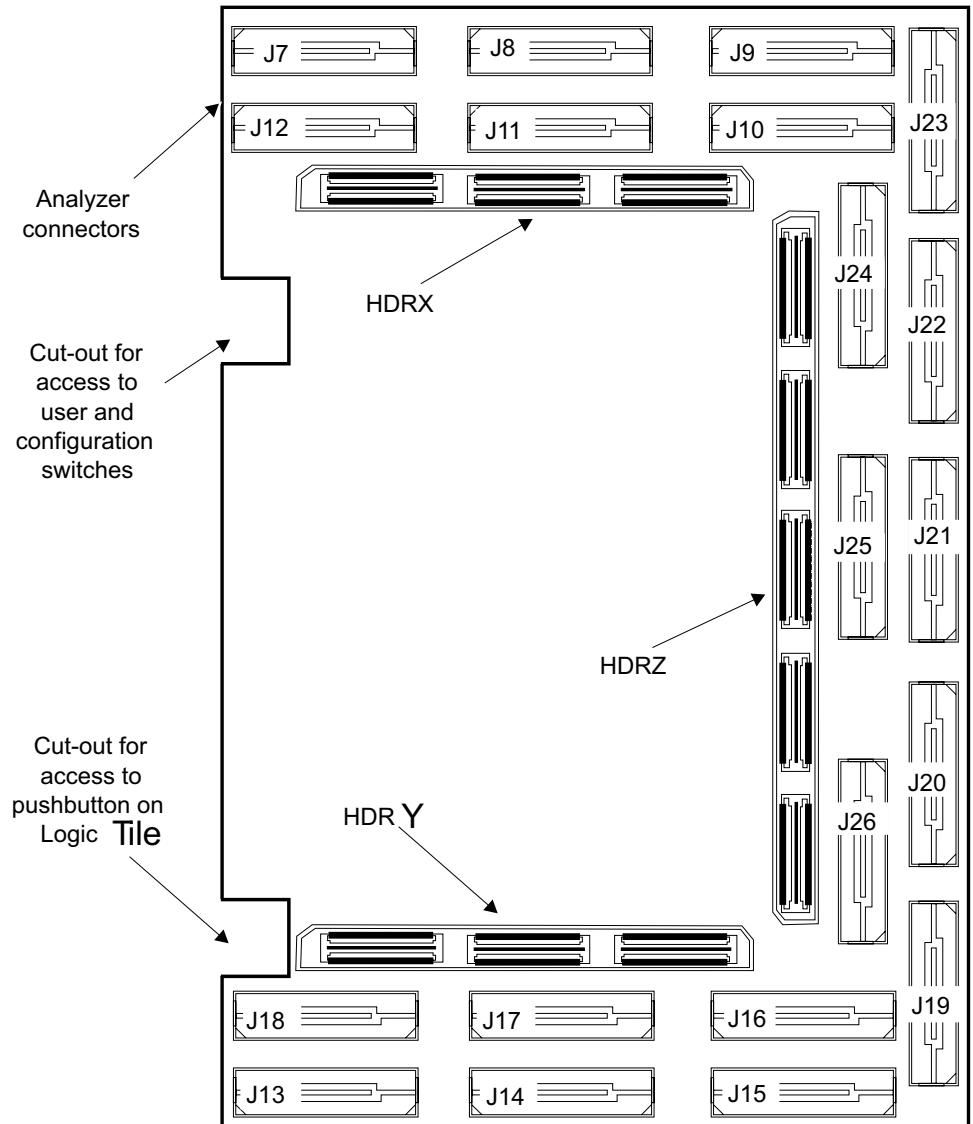

Figure 1-1 Analyzer Tile layout

Chapter 2

Using the Analyzer Tile

This chapter describes how to set up and prepare the Analyzer Tile for use. It contains the following sections:

- *Connecting the Analyzer Tile* on page 2-2
- *Mictor connectors* on page 2-4.

2.1 Connecting the Analyzer Tile

The Analyzer Tile connects on top of a Logic Tile, or between tiles as shown in Figure 2-1, to monitor tile signals. The Analyzer Tile can also be connected directly on top of the Versatile Platform Baseboard for ARM926EJ-S.

The Analyzer Tile cannot, however, be connected directly on top of an Integrator/IM-LT1 or Integrator/IM-LT2 Interface Module

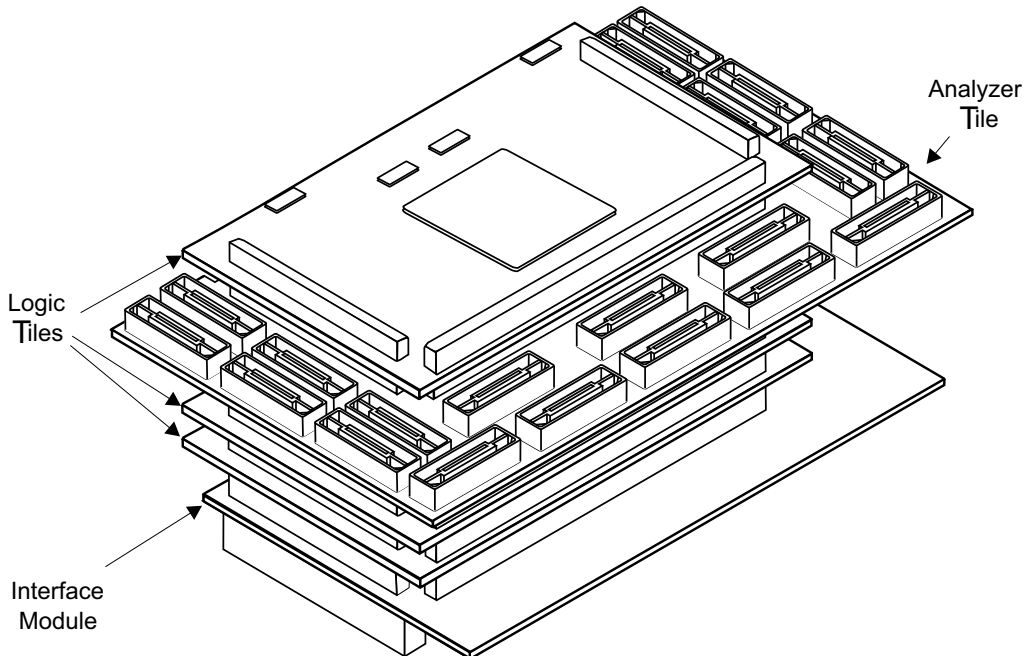

Figure 2-1 Interface Tile mounted on logic tile and interface module

All signals from the Logic Tile pass directly through the Analyzer Tile as shown in Figure 2-2 on page 2-3. There is no buffering or rotation of signals between the headers

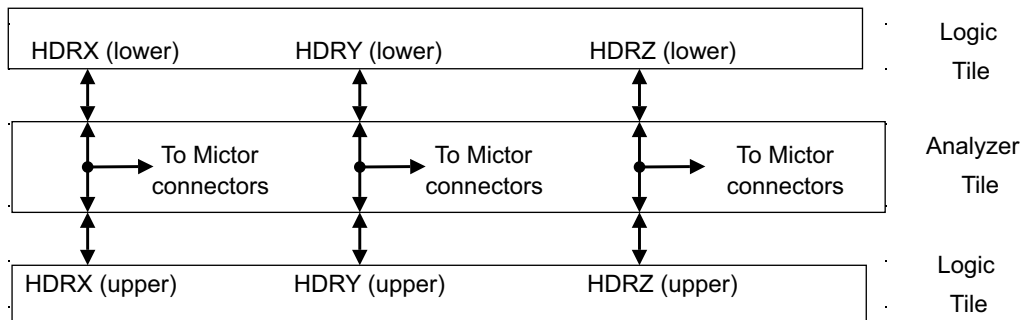

Figure 2-2 Logic Tile signals

2.2 Mictor connectors

Connect your logic analyzer to the Analyzer Tile using the high-density AMP Mictor connectors (AMP 2-767004-2). Each one of these connectors carries up to 32 signals and 2 clocks (or clock qualifiers). Figure 2-3 shows the connector and identification of pin 1.

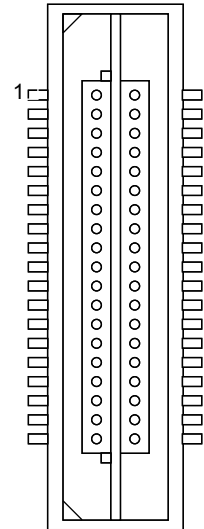

Figure 2-3 AMP Mictor connector

Agilent and Tektronix label these connectors differently, but the assignments of signals to physical pins is appropriate for both systems and pin 1 is always in the same place. The schematic is labeled according to the Agilent pin assignment.

———— **Note** ————

Pin 1 is labelled as +5VDC on the Agilent pin assignment, however it has no connection on the Analyzer Tile because the voltage is not required. Pin 2 is labelled as NC on the Tektronix in assignment, however it is connected to GND on the Analyzer Tile to maintain compatibility with the Agilent pin assignments.

The connectors provide access to:

- All I/O signals on HDRX, HDRY, and HDRZ
- JTAG signals
- Clock signals
- Reset signals.

2.2.1 Using an Agilent logic analyzer

Agilent label the signals as shown in Table 2-1. The Agilent E5346A 38-pin Probe can be used with an Agilent logic analyzer and the Analyzer Tile.

Table 2-1 Agilent logic analyzer probe

Channel	Pin	Pin	Channel
+5VDC	1	2	NC
GND	3	4	NC
LCLK	5	6	HCLK
D15 EVEN	7	8	D15 ODD
D14 EVEN	9	10	D14 ODD
D13 EVEN	11	12	D13 ODD
D12 EVEN	13	14	D12 ODD
D11 EVEN	15	16	D11 ODD
D10 EVEN	17	18	D10 ODD
D9 EVEN	19	20	D9 ODD
D8 EVEN	21	22	D8 ODD
D7 EVEN	23	24	D7 ODD
D6 EVEN	25	26	D6 ODD
D5 EVEN	27	28	D5 ODD
D4 EVEN	29	30	D4 ODD
D3 EVEN	31	32	D3 ODD
D2 EVEN	33	34	D2 ODD
D1 EVEN	35	36	D1 ODD
D0 EVEN	37	38	D0 ODD

2.2.2 Using an Tektronix logic analyzer

Tektronix label the signals as shown in Table 2-2. The Tektronix P6434 Mass Termination Probe can be used with a Tektronix logic analyzer and the Analyzer Tile.

Table 2-2 Tektronix logic analyzer probe

Channel	Pin	Pin	Channel
NC	1	38	NC
NC	2	37	NC
CLK/QUAL	3	36	CLK/QUAL
D3:7	4	35	D1:7
D3:6	5	34	D1:6
D3:5	6	33	D1:5
D3:4	7	32	D1:4
D3:3	8	31	D1:3
D3:2	9	30	D1:2
D3:1	10	29	D1:1
D3:0	11	28	D1:0
D2:7	12	27	D0:7
D2:6	13	26	D0:6
D2:5	14	25	D0:5
D2:4	15	24	D0:4
D2:3	16	23	D0:3
D2:2	17	22	D0:2
D2:1	18	21	D0:1
D2:0	19	20	D0:0

2.3 Signal description

This section describes the signals present on the Analyzer Tile.

2.3.1 Connector summary

Table 2-3 describes the signal allocation of each of the connectors. See *Logic analyzer connectors* on page A-4 for detailed pinouts.

Table 2-3 Connector summary

Mictor connector	Logic Tile signals	Clocks and qualifiers
J7	[X31:X0]	CLK_POS_UP, X128
J8	[X63:X32]	CLK_DN_MINUS1, X129
J9	[X95:X64]	CLK_POS_UP, X130
J10	[X127:X96]	CLK_POS_DN, X131
J11	[X159:X128]	CLK_GLOBAL, X178
J12	[X179:X160], Configuration JTAG	C_TCK, X179
J13	Y[31:Y0]	CLK_UP_PLUS1, X128
J14	Y[63:Y32]	CLK_DN_MINUS1, Y129
J15	Y[95:Y64]	CLK_NEG_UP, Y130
J16	Y[127:Y96]	CLK_NEG_DN, Y131
J17	Y[152:Y132], SPARE[10:0]	CLK_GLOBAL, Y178
J18	Y[176:1Y53], Debug JTAG	D_TCK, Y179
J19	Z[31:Z0]	CLK_UP_PLUS1, Z95
J20	Z[63:Z32]	CLK_DN_MINUS1, Z94
J21	Z[95:Z64]	CLK_UP_PLUS2, Z59 ^a
J22	Z[191:Z160]	CLK_DN_MINUS2, Z128
J23	Z[159:128]	CLK_POS_UP, CLK_POS_DN

Table 2-3 Connector summary (continued)

Mictor connector	Logic Tile signals	Clocks and qualifiers
J24	Z[255:224]	CLK_UP_THRU, Z255
J25	Z[223:192]	CLK_DN_THRU, Z129
J26	Z[127:96]	CLK_GLOBAL, Z44 ^b

- a. Z59 is connected to C27 when tiles are mounted on an Integrator/IM-LT1. This signal is not used on an Integrator/AP.
- b. Z44 is connected to C12 (HREADY) when tiles are mounted on an Integrator/IM-LT1.

2.3.2 Clock connections

Figure 2-4 on page 2-9 shows the clock signals on the header pins and the connection to the logic analyzer connectors.

The clock signals are not buffered between the top and bottom tile headers. However, most of the Logic Tile clocks are buffered before routing to the logic analyzer connectors. The buffering prevents loading on the clock signal. The unbuffered clocks, however, permit more accurate measurements of setup and hold times. Some of the clocks are also connected to test points for easy access, see Table A-1 on page A-3. See Appendix A Pinouts and Specifications for a complete list of connector pinouts.

———— **Note** —————

For the Analyzer Tile, signals on the lower Logic Tile connectors (HDRX, HDRY, and HDRZ) are connected to the same pin on the upper Logic Tile connectors. There are no rotated, buffered, or modified signals on the tile header connectors.

The signal names on the upper and lower HDRZ Logic Tile connectors shown in Figure 2-4 on page 2-9 are different because some signals are rotated or buffered on the Logic Tile.

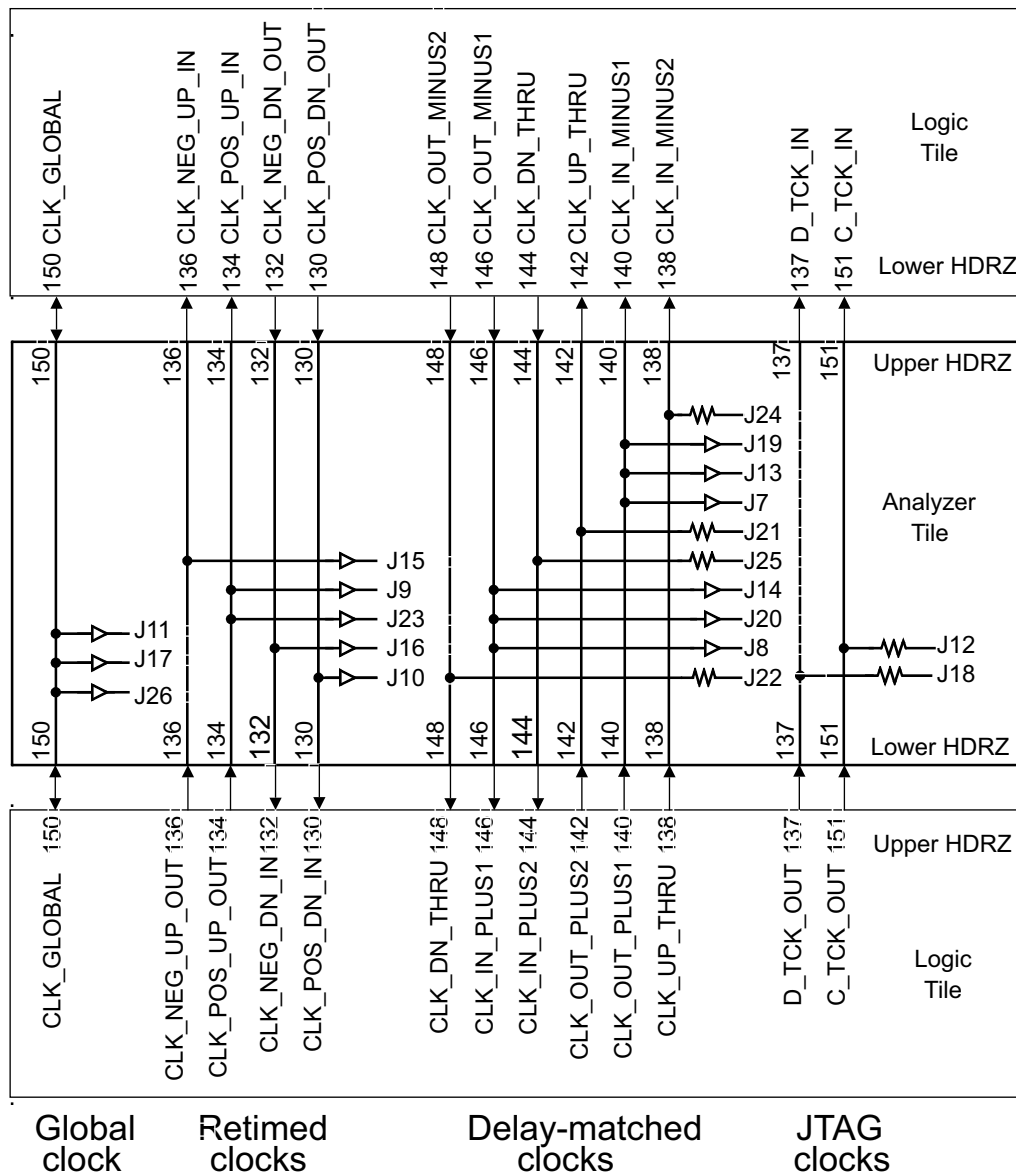

Figure 2-4 HDRZ clock signals

2.3.3 JTAG signals

The Analyzer Tile does not have a JTAG connector.

If you are using a JTAG debugger with an Integrator/AP baseboard, connect the debugger to the Integrator/IM-LT1 or IM-LT2 Interface Module. The Logic Tile JTAG signals can be monitored from logic analyzer connector J12 and J18, see *Mictor connector J12, JTAG and X179-X160* on page A-9 and *Mictor connector J18, JTAG and Y179-Y153* on page A-15. Refer to the *Multi-ICE User Guide* and the *Integrator/IM-LT1 User Guide* for more details.

If you are using a JTAG debugger with the Versatile Platform Baseboard for ARM926EJ-S, use the JTAG interface on the baseboard.

2.3.4 Trace signals

The Analyzer Tile does not have a dedicated trace port connector.

If you are using an Integrator/AP baseboard, the Mictor connectors on the Analyzer Tile can be used to output trace signals if an appropriate design is placed in the Logic Tile. Use this option if the trace signals are not routed down to the Interface Module. For example, they may have been replaced by I/O signals. Mictor connector J18 contains the JTAG run control signals and is recommended for use as the trace connector. If the Logic Tile trace signals are routed down to the Interface Module such as the Integrator/IM-LT1, you can use the trace connector on the Interface Module.

If you are using the Versatile Platform Baseboard for ARM926EJ-S, use the Trace Port interface on the baseboard.

Appendix A

Pinouts and Specifications

This appendix describes the connectors on the Analyzer Tile and the Analyzer Tile specifications. It contains the following sections:

- *Test points* on page A-2
- *Logic analyzer connectors* on page A-4
- *Tile connections* on page A-24
- *Electrical specification* on page A-39
- *Mechanical specification* on page A-40.

A.1 Test points

The Analyzer Tile provides test points and ground points to aid diagnostics as shown in Figure A-1 and Table A-1 on page A-3.

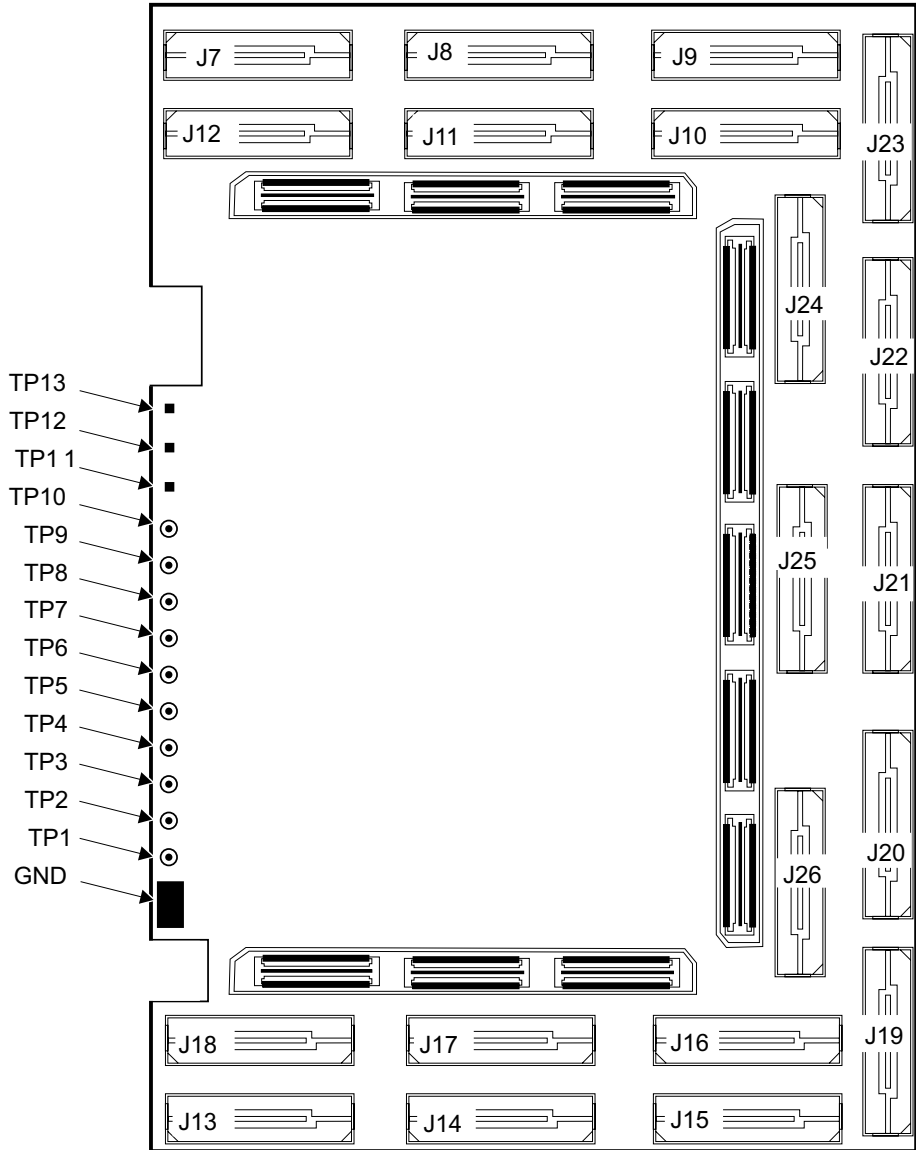

Figure A-1 Test points

The functions of these test points are summarized in Table A-1.

Table A-1 Test connections

Test point	Description
1	Buffered CLK_NEG_DN
2	Buffered CLK_NEG_UP
3	Buffered CLK_DN_MINUS1
4	Buffered CLK_UP_PLUS1
5	Buffered CLK_POS_DN
6	Buffered CLK_POS_UP
7	Buffered CLK_GLOBAL
8	GLOBAL_DONE
9	nSYSRST
10	nSYSPOR
11	(not fitted)
12	(not fitted)
13	(not fitted)

A.2 Logic analyzer connectors

The tile signals on the analyzer connectors are shown in Table A-20 on page A-22 to Table A-16 on page A-18. For a description of Agilent and Tektronix pin numbering and pin names, see Table 2-1 on page 2-5 and Table 2-2 on page 2-6.

Table A-2 Mictor connector J7, X31-X0

Tile signal	Agilent pin number (Tektronix number)		Tile signal
NC	1 (1)	2 (38)	NC
GND	3 (2)	4 (37)	NC
CLK_UP_PLUS1 (buffered)	5 (3)	6 (36)	X128
X31	7 (4)	8 (35)	X15
X30	9 (5)	10 (34)	X14
X29	11 (6)	12 (33)	X13
X28	13 (7)	14 (32)	X12
X27	15 (8)	16 (31)	X11
X26	17 (9)	18 (30)	X10
X25	19 (10)	20 (29)	X9
X24	21 (11)	22 (28)	X8
X23	23 (12)	24 (27)	X7
X22	25 (13)	26 (26)	X6
X21	27 (14)	28 (25)	X5
X20	29 (15)	30 (24)	X4
X19	31 (16)	32 (23)	X3
X18	33 (17)	34 (22)	X2
X17	35 (18)	36 (21)	X1
X16	37 (19)	38 (20)	X0

Table A-3 Mictor connector J8, X63-X32

Tile signal	Agilent pin number (Tektronix number)		Tile signal
NC	1 (1)	2 (38)	NC
GND	3 (2)	4 (37)	NC
CLK_DN_MINUS1 (buffered)	5 (3)	6 (36)	X129
X63	7 (4)	8 (35)	X47
X62	9 (5)	10 (34)	X46
X61	11 (6)	12 (33)	X45
X60	13 (7)	14 (32)	X44
X59	15 (8)	16 (31)	X43
X58	17 (9)	18 (30)	X42
X57	19 (10)	20 (29)	X41
X56	21 (11)	22 (28)	X40
X55	23 (12)	24 (27)	X39
X54	25 (13)	26 (26)	X38
X53	27 (14)	28 (25)	X37
X52	29 (15)	30 (24)	X36
X51	31 (16)	32 (23)	X35
X50	33 (17)	34 (22)	X34
X49	35 (18)	36 (21)	X33
X48	37 (19)	38 (20)	X32

Table A-4 Mictor connector J9, X95-X64

Tile signal	Agilent pin number (Tektronix number)		Tile signal
NC	1 (1)	2 (38)	NC
GND	3 (2)	4 (37)	NC
CLK_POS_UP (buffered)	5 (3)	6 (36)	X130
X95	7 (4)	8 (35)	X79
X94	9 (5)	10 (34)	X78
X93	11 (6)	12 (33)	X77
X92	13 (7)	14 (32)	X76
X91	15 (8)	16 (31)	X75
X90	17 (9)	18 (30)	X74
X89	19 (10)	20 (29)	X73
X88	21 (11)	22 (28)	X72
X87	23 (12)	24 (27)	X71
X86	25 (13)	26 (26)	X70
X85	27 (14)	28 (25)	X69
X84	29 (15)	30 (24)	X68
X83	31 (16)	32 (23)	X67
X82	33 (17)	34 (22)	X66
X81	35 (18)	36 (21)	X65
X80	37 (19)	38 (20)	X64

Table A-5 Mictor connector J10, X127-X96

Tile signal	Agilent pin number (Tektronix number)		Tile signal
NC	1 (1)	2 (38)	NC
GND	3 (2)	4 (37)	NC
CLK_POS_DN (buffered)	5 (3)	6 (36)	X131
X127	7 (4)	8 (35)	X111
X126	9 (5)	10 (34)	X110
X125	11 (6)	12 (33)	X109
X124	13 (7)	14 (32)	X108
X123	15 (8)	16 (31)	X107
X122	17 (9)	18 (30)	X106
X121	19 (10)	20 (29)	X105
X120	21 (11)	22 (28)	X104
X119	23 (12)	24 (27)	X103
X118	25 (13)	26 (26)	X102
X117	27 (14)	28 (25)	X101
X116	29 (15)	30 (24)	X100
X115	31 (16)	32 (23)	X99
X114	33 (17)	34 (22)	X98
X113	35 (18)	36 (21)	X97
X112	37 (19)	38 (20)	X96

Table A-6 Mictor connector J11, X159-X128

Tile signal	Agilent pin number (Tektronix number)		Tile signal
NC	1 (1)	2 (38)	NC
GND	3 (2)	4 (37)	NC
CLK_GLOBAL (buffered)	5 (3)	6 (36)	X178
X159	7 (4)	8 (35)	X143
X158	9 (5)	10 (34)	X142
X157	11 (6)	12 (33)	X141
X156	13 (7)	14 (32)	X140
X155	15 (8)	16 (31)	X139
X154	17 (9)	18 (30)	X138
X153	19 (10)	20 (29)	X137
X152	21 (11)	22 (28)	X136
X151	23 (12)	24 (27)	X135
X150	25 (13)	26 (26)	X134
X149	27 (14)	28 (25)	X133
X148	29 (15)	30 (24)	X132
X147	31 (16)	32 (23)	X131
X146	33 (17)	34 (22)	X130
X145	35 (18)	36 (21)	X129
X144	37 (19)	38 (20)	X128

Table A-7 Mictor connector J12, JTAG and X179-X160

Tile signal	Agilent pin number (Tektronix number)		Tile signal
NC	1 (1)	2 (38)	NC
GND	3 (2)	4 (37)	NC
C_TCK (unbuffered)	5 (3)	6 (36)	X179
NC	7 (4)	8 (35)	X175
C_nSRST	9 (5)	10 (34)	X174
C_TDO	11 (6)	12 (33)	X173
NC	13 (7)	14 (32)	X172
C_TCK (unbuffered)	15 (8)	16 (31)	X171
C_TMS	17 (9)	18 (30)	X170
C_TDI	19 (10)	20 (29)	X169
C_nTRST	21 (11)	22 (28)	X168
GLOBAL_DONE	23 (12)	24 (27)	X167
nSYSRST	25 (13)	26 (26)	X166
nSYSPOR	27 (14)	28 (25)	X165
SPARE12	29 (15)	30 (24)	X164
SPARE11	31 (16)	32 (23)	X163
X178	33 (17)	34 (22)	X162
X177	35 (18)	36 (21)	X161
X176	37 (19)	38 (20)	X160

Table A-8 Mictor connector J13, Y31-Y0

Tile signal	Agilent pin number (Tektronix number)		Tile signal
NC	1 (1)	2 (38)	NC
GND	3 (2)	4 (37)	NC
CLK_UP_PLUS1 (buffered)	5 (3)	6 (36)	Y128
Y31	7 (4)	8 (35)	Y15
Y30	9 (5)	10 (34)	Y14
Y29	11 (6)	12 (33)	Y13
Y28	13 (7)	14 (32)	Y12
Y27	15 (8)	16 (31)	Y11
Y26	17 (9)	18 (30)	Y10
Y25	19 (10)	20 (29)	Y9
Y24	21 (11)	22 (28)	Y8
Y23	23 (12)	24 (27)	Y7
Y22	25 (13)	26 (26)	Y6
Y21	27 (14)	28 (25)	Y5
Y20	29 (15)	30 (24)	Y4
Y19	31 (16)	32 (23)	Y3
Y18	33 (17)	34 (22)	Y2
Y17	35 (18)	36 (21)	Y1
Y16	37 (19)	38 (20)	Y0

Table A-9 Mictor connector J14, Y63-Y32

Tile signal	Agilent pin number (Tektronix number)		Tile signal
NC	1 (1)	2 (38)	NC
GND	3 (2)	4 (37)	NC
CLK_DN_MINUS1 (buffered)	5 (3)	6 (36)	Y129
Y63	7 (4)	8 (35)	Y47
Y62	9 (5)	10 (34)	Y46
Y61	11 (6)	12 (33)	Y45
Y60	13 (7)	14 (32)	Y44
Y59	15 (8)	16 (31)	Y43
Y58	17 (9)	18 (30)	Y42
Y57	19 (10)	20 (29)	Y41
Y56	21 (11)	22 (28)	Y40
Y55	23 (12)	24 (27)	Y39
Y54	25 (13)	26 (26)	Y38
Y53	27 (14)	28 (25)	Y37
Y52	29 (15)	30 (24)	Y36
Y51	31 (16)	32 (23)	Y35
Y50	33 (17)	34 (22)	Y34
Y49	35 (18)	36 (21)	Y33
Y48	37 (19)	38 (20)	Y32

Table A-10 Mictor connector J15, Y95-Y64

Tile signal	Agilent pin number (Tektronix number)		Tile signal
NC	1 (1)	2 (38)	NC
GND	3 (2)	4 (37)	NC
CLK_NEG_UP (buffered)	5 (3)	6 (36)	Y130
Y95	7 (4)	8 (35)	Y79
Y94	9 (5)	10 (34)	Y78
Y93	11 (6)	12 (33)	Y77
Y92	13 (7)	14 (32)	Y76
Y91	15 (8)	16 (31)	Y75
Y90	17 (9)	18 (30)	Y74
Y89	19 (10)	20 (29)	Y73
Y88	21 (11)	22 (28)	Y72
Y87	23 (12)	24 (27)	Y71
Y86	25 (13)	26 (26)	Y70
Y85	27 (14)	28 (25)	Y69
Y84	29 (15)	30 (24)	Y68
Y83	31 (16)	32 (23)	Y67
Y82	33 (17)	34 (22)	Y66
Y81	35 (18)	36 (21)	Y65
Y80	37 (19)	38 (20)	Y64

Table A-11 Mictor connector J16, Y127-Y96

Tile signal	Agilent pin number (Tektronix number)		Tile signal
NC	1 (1)	2 (38)	NC
GND	3 (2)	4 (37)	NC
CLK_NEG_DN (buffered)	5 (3)	6 (36)	Y131
Y127	7 (4)	8 (35)	Y111
Y126	9 (5)	10 (34)	Y110
Y125	11 (6)	12 (33)	Y109
Y124	13 (7)	14 (32)	Y108
Y123	15 (8)	16 (31)	Y107
Y122	17 (9)	18 (30)	Y106
Y121	19 (10)	20 (29)	Y105
Y120	21 (11)	22 (28)	Y104
Y119	23 (12)	24 (27)	Y103
Y118	25 (13)	26 (26)	Y102
Y117	27 (14)	28 (25)	Y101
Y116	29 (15)	30 (24)	Y100
Y115	31 (16)	32 (23)	Y99
Y114	33 (17)	34 (22)	Y98
Y113	35 (18)	36 (21)	Y97
Y112	37 (19)	38 (20)	Y96

Table A-12 Mictor connector J17, SPARE and Y152-Y132

Tile signal	Agilent pin number (Tektronix number)		Tile signal
NC	1 (1)	2 (38)	NC
GND	3 (2)	4 (37)	NC
CLK_GLOBAL (buffered)	5 (3)	6 (36)	Y178
SPARE10	7 (4)	8 (35)	Y147
SPARE9	9 (5)	10 (34)	Y146
SPARE8	11 (6)	12 (33)	Y145
SPARE7	13 (7)	14 (32)	Y144
SPARE6	15 (8)	16 (31)	Y143
SPARE5	17 (9)	18 (30)	Y142
SPARE4	19 (10)	20 (29)	Y141
SPARE3	21 (11)	22 (28)	Y140
SPARE2	23 (12)	24 (27)	Y139
SPARE1	25 (13)	26 (26)	Y138
SPARE0	27 (14)	28 (25)	Y137
Y152	29 (15)	30 (24)	Y136
Y151	31 (16)	32 (23)	Y135
Y150	33 (17)	34 (22)	Y134
Y149	35 (18)	36 (21)	Y133
Y148	37 (19)	38 (20)	Y132

Table A-13 Mictor connector J18, JTAG and Y179-Y153

Tile signal	Agilent pin number (Tektronix number)		Tile signal
NC	1 (1)	2 (38)	NC
GND	3 (2)	4 (37)	NC
D_TCK (unbuffered)	5 (3)	6 (36)	Y179
Y177	7 (4)	8 (35)	Y168
D_nSRST	9 (5)	10 (34)	Y167
D_TDO	11 (6)	12 (33)	Y166 (1KO pull up to VCCO_Y)
D_RTCK	13 (7)	14 (32)	Y165 (1KO pull up to 3.3V)
D_TCK (unbuffered)	15 (8)	16 (31)	Y164
D_TMS	17 (9)	18 (30)	Y163
D_TDI	19 (10)	20 (29)	Y162
D_nTRST	21 (11)	22 (28)	Y161
Y176	23 (12)	24 (27)	Y160
Y175	25 (13)	26 (26)	Y159
Y174	27 (14)	28 (25)	Y158
Y173	29 (15)	30 (24)	Y157
Y172	31 (16)	32 (23)	Y156
Y171	33 (17)	34 (22)	Y155
Y170	35 (18)	36 (21)	Y154
Y169	37 (19)	38 (20)	Y153

Table A-14 Mictor connector J19, Z31-Z0

Tile signal	Agilent pin number (Tektronix number)		Tile signal
NC	1 (1)	2 (38)	NC
GND	3 (2)	4 (37)	NC
CLK_UP_PLUS1 (buffered)	5 (3)	6 (36)	Z95
Z31	7 (4)	8 (35)	Z15
Z30	9 (5)	10 (34)	Z14
Z29	11 (6)	12 (33)	Z13
Z28	13 (7)	14 (32)	Z12
Z27	15 (8)	16 (31)	Z11
Z26	17 (9)	18 (30)	Z10
Z25	19 (10)	20 (29)	Z9
Z24	21 (11)	22 (28)	Z8
Z23	23 (12)	24 (27)	Z7
Z22	25 (13)	26 (26)	Z6
Z21	27 (14)	28 (25)	Z5
Z20	29 (15)	30 (24)	Z4
Z19	31 (16)	32 (23)	Z3
Z18	33 (17)	34 (22)	Z2
Z17	35 (18)	36 (21)	Z1
Z16	37 (19)	38 (20)	Z0

Table A-15 Mictor connector J20, Z63-Z32

Tile signal	Agilent pin number (Tektronix number)		Tile signal
NC	1 (1)	2 (38)	NC
GND	3 (2)	4 (37)	NC
CLK_DN_MINUS1 (buffered)	5 (3)	6 (36)	Z94
Z63	7 (4)	8 (35)	Z47
Z62	9 (5)	10 (34)	Z46
Z61	11 (6)	12 (33)	Z45
Z60	13 (7)	14 (32)	Z44
Z59	15 (8)	16 (31)	Z43
Z58	17 (9)	18 (30)	Z42
Z57	19 (10)	20 (29)	Z41
Z56	21 (11)	22 (28)	Z40
Z55	23 (12)	24 (27)	Z39
Z54	25 (13)	26 (26)	Z38
Z53	27 (14)	28 (25)	Z37
Z52	29 (15)	30 (24)	Z36
Z51	31 (16)	32 (23)	Z35
Z50	33 (17)	34 (22)	Z34
Z49	35 (18)	36 (21)	Z33
Z48	37 (19)	38 (20)	Z32

Table A-16 Mictor connector J21, Z95-Z64

Tile signal	Agilent pin number (Tektronix number)		Tile signal
NC	1 (1)	2 (38)	NC
GND	3 (2)	4 (37)	NC
CLK_UP_PLUS2 (unbuffered)	5 (3)	6 (36)	Z59
Z95	7 (4)	8 (35)	Z79
Z94	9 (5)	10 (34)	Z78
Z93	11 (6)	12 (33)	Z77
Z92	13 (7)	14 (32)	Z76
Z91	15 (8)	16 (31)	Z75
Z90	17 (9)	18 (30)	Z74
Z89	19 (10)	20 (29)	Z73
Z88	21 (11)	22 (28)	Z72
Z87	23 (12)	24 (27)	Z71
Z86	25 (13)	26 (26)	Z70
Z85	27 (14)	28 (25)	Z69
Z84	29 (15)	30 (24)	Z68
Z83	31 (16)	32 (23)	Z67
Z82	33 (17)	34 (22)	Z66
Z81	35 (18)	36 (21)	Z65
Z80	37 (19)	38 (20)	Z64

Table A-17 Mictor connector J22, Z191-Z160

Tile signal	Agilent pin number (Tektronix number)		Tile signal
NC	1 (1)	2 (38)	NC
GND	3 (2)	4 (37)	NC
CLK_DN_MINUS2 (unbuffered)	5 (3)	6 (36)	Z128
Z191	7 (4)	8 (35)	Z175
Z190	9 (5)	10 (34)	Z174
Z189	11 (6)	12 (33)	Z173
Z188	13 (7)	14 (32)	Z172
Z187	15 (8)	16 (31)	Z171
Z186	17 (9)	18 (30)	Z170
Z185	19 (10)	20 (29)	Z169
Z184	21 (11)	22 (28)	Z168
Z183	23 (12)	24 (27)	Z167
Z182	25 (13)	26 (26)	Z166
Z181	27 (14)	28 (25)	Z165
Z180	29 (15)	30 (24)	Z164
Z179	31 (16)	32 (23)	Z163
Z178	33 (17)	34 (22)	Z162
Z177	35 (18)	36 (21)	Z161
Z176	37 (19)	38 (20)	Z160

Table A-18 Mictor connector J23, Z159-Z128

Tile signal	Agilent pin number (Tektronix number)		Tile signal
NC	1 (1)	2 (38)	NC
GND	3 (2)	4 (37)	NC
CLK_POS_UP (buffered)	5 (3)	6 (36)	CLK_POS_DN (buffered)
Z159	7 (4)	8 (35)	Z143
Z158	9 (5)	10 (34)	Z142
Z157	11 (6)	12 (33)	Z141
Z156	13 (7)	14 (32)	Z140
Z155	15 (8)	16 (31)	Z139
Z154	17 (9)	18 (30)	Z138
Z153	19 (10)	20 (29)	Z137
Z152	21 (11)	22 (28)	Z136
Z151	23 (12)	24 (27)	Z135
Z150	25 (13)	26 (26)	Z134
Z149	27 (14)	28 (25)	Z133
Z148	29 (15)	30 (24)	Z132
Z147	31 (16)	32 (23)	Z131
Z146	33 (17)	34 (22)	Z130
Z145	35 (18)	36 (21)	Z129

Table A-19 Mictor connector J24, Z255-Z224

Tile signal	Agilent pin number (Tektronix number)		Tile signal
NC	1 (1)	2 (38)	NC
GND	3 (2)	4 (37)	NC
CLK_UP_THRU (unbuffered)	5 (3)	6 (36)	Z255
Z255	7 (4)	8 (35)	Z239
Z254	9 (5)	10 (34)	Z238
Z253	11 (6)	12 (33)	Z237
Z252	13 (7)	14 (32)	Z236
Z251	15 (8)	16 (31)	Z235
Z250	17 (9)	18 (30)	Z234
Z249	19 (10)	20 (29)	Z233
Z248	21 (11)	22 (28)	Z232
Z247	23 (12)	24 (27)	Z231
Z246	25 (13)	26 (26)	Z230
Z245	27 (14)	28 (25)	Z229
Z244	29 (15)	30 (24)	Z228
Z243	31 (16)	32 (23)	Z227
Z242	33 (17)	34 (22)	Z226
Z241	35 (18)	36 (21)	Z225
Z240	37 (19)	38 (20)	Z224

Table A-20 Mictor connector J25, Z223-Z192

Tile signal	Agilent pin number (Tektronix number)		Tile signal
NC	1 (1)	2 (38)	NC
GND	3 (2)	4 (37)	NC
CLK_DN_THRU (unbuffered)	5 (3)	6 (36)	Z129
Z223	7 (4)	8 (35)	Z207
Z222	9 (5)	10 (34)	Z206
Z221	11 (6)	12 (33)	Z205
Z220	13 (7)	14 (32)	Z204
Z219	15 (8)	16 (31)	Z203
Z218	17 (9)	18 (30)	Z202
Z217	19 (10)	20 (29)	Z201
Z216	21 (11)	22 (28)	Z200
Z215	23 (12)	24 (27)	Z199
Z214	25 (13)	26 (26)	Z198
Z213	27 (14)	28 (25)	Z197
Z212	29 (15)	30 (24)	Z196
Z211	31 (16)	32 (23)	Z195
Z210	33 (17)	34 (22)	Z194
Z209	35 (18)	36 (21)	Z193
Z208	37 (19)	38 (20)	Z192

Table A-21 Mictor connector J26, Z127-Z96

Tile signal	Agilent pin number (Tektronix number)		Tile signal
NC	1 (1)	2 (38)	NC
GND	3 (2)	4 (37)	NC
CLK_GLOBAL (buffered)	5 (3)	6 (36)	Z44
Z127	7 (4)	8 (35)	Z111
Z126	9 (5)	10 (34)	Z110
Z125	11 (6)	12 (33)	Z109
Z124	13 (7)	14 (32)	Z108
Z123	15 (8)	16 (31)	Z107
Z122	17 (9)	18 (30)	Z106
Z121	19 (10)	20 (29)	Z105
Z120	21 (11)	22 (28)	Z104
Z119	23 (12)	24 (27)	Z103
Z118	25 (13)	26 (26)	Z102
Z117	27 (14)	28 (25)	Z101
Z116	29 (15)	30 (24)	Z100
Z115	31 (16)	32 (23)	Z99
Z114	33 (17)	34 (22)	Z98
Z113	35 (18)	36 (21)	Z97
Z112	37 (19)	38 (20)	Z96

A.3 Tile connections

This section lists the signals on the tile connectors.

Note

Unlike the signals on Logic Tiles, all Analyzer Tile signals are the same on both the top and bottom tile connectors and there is no rotation or buffering of signals.

A.3.1 HDRX

Table A-22 describes the signals on the HDRX pins.

Table A-22 HDRX signals

Signal	Pin	Pin	Signal
Xx90	1	2	Xx89
Xx91	3	4	Xx88
Xx92	5	6	Xx87
Xx93	7	8	Xx86
Xx94	9	10	Xx85
Xx95	11	12	Xx84
Xx96	13	14	Xx83
Xx97	15	16	Xx82
Xx98	17	18	Xx81
Xx99	19	20	Xx80
Xx100	21	22	Xx79
Xx101	23	24	Xx78
Xx102	25	26	Xx77
Xx103	27	28	Xx76
Xx104	29	30	Xx75
Xx105	31	32	Xx74
Xx106	33	34	Xx73

Table A-22 HDRX signals (continued)

Signal	Pin	Pin	Signal
Xx107	35	36	Xx72
Xx108	37	38	Xx71
Xx109	39	40	Xx70
Xx110	41	42	Xx69
Xx111	43	44	Xx68
Xx112	45	46	Xx67
Xx113	47	48	Xx66
Xx114	49	50	Xx65
Xx115	51	52	Xx64
Xx116	53	54	Xx63
Xx117	55	56	Xx62
Xx118	57	58	Xx61
Xx119	59	60	Xx60
Xx120	61	62	Xx59
Xx121	63	64	Xx58
Xx122	65	66	Xx57
Xx123	67	68	Xx56
Xx124	69	70	Xx55
Xx125	71	72	Xx54
Xx126	73	74	Xx53
Xx127	75	76	Xx52
Xx128	77	78	Xx51
Xx129	79	80	Xx50
Xx130	81	82	Xx49
Xx131	83	84	Xx48

Table A-22 HDRX signals (continued)

Signal	Pin	Pin	Signal
Xx132	85	86	Xx47
Xx133	87	88	Xx46
Xx134	89	90	Xx45
Xx135	91	92	Xx44
Xx136	93	94	Xx43
Xx137	95	96	Xx42
Xx138	97	98	Xx41
Xx139	99	100	Xx40
Xx140	101	102	Xx39
Xx141	103	104	Xx38
Xx142	105	106	Xx37
Xx143	107	108	Xx36
Xx144	109	110	Xx35
Xx145	111	112	Xx34
Xx146	113	114	Xx33
Xx147	115	116	Xx32
Xx148	117	118	Xx31
Xx149	119	120	Xx30
Xx150	121	122	Xx29
Xx151	123	124	Xx28
Xx152	125	126	Xx27
Xx153	127	128	Xx26
Xx154	129	130	Xx25
Xx155	131	132	Xx24
Xx156	133	134	Xx23

Table A-22 HDRX signals (continued)

Signal	Pin	Pin	Signal
Xx157	135	136	Xx22
Xx158	137	138	Xx21
Xx159	139	140	Xx20
Xx160	141	142	Xx19
Xx161	143	144	Xx18
Xx162	145	146	Xx17
Xx163	147	148	Xx16
Xx164	149	150	Xx15
Xx165	151	152	Xx14
Xx166	153	154	Xx13
Xx167	155	156	Xx12
Xx168	157	158	Xx11
Xx169	159	160	Xx10
Xx170	161	162	Xx9
Xx171	163	164	Xx8
Xx172	165	166	Xx7
Xx173	167	168	Xx6
Xx174	169	170	Xx5
Xx175	171	172	Xx4
Xx176	173	174	Xx3
Xx177	175	176	Xx2
Xx178	177	178	Xx1
Xx179	179	180	Xx0

A.3.2 HDRY

Table A-23 describes the signals on the HDRY pins.

Table A-23 HDRY signals

Signal	Odd pins		Even pins	
	Pin	Pin	Pin	Signal
Yx89	1	2	Yx90	
Yx88	3	4	Yx91	
Yx87	5	6	Yx92	
Yx86	7	8	Yx93	
Yx85	9	10	Yx94	
Yx84	11	12	Yx95	
Yx83	13	14	Yx96	
Yx82	15	16	Yx97	
Yx81	17	18	Yx98	
Yx80	19	20	Yx99	
Yx79	21	22	Yx100	
Yx78	23	24	Yx101	
Yx77	25	26	Yx102	
Yx76	27	28	Yx103	
Yx75	29	30	Yx104	
Yx74	31	32	Yx105	
Yx73	33	34	Yx106	
Yx72	35	36	Yx107	
Yx71	37	38	Yx108	
Yx70	39	40	Yx109	
Yx69	41	42	Yx110	
Yx68	43	44	Yx111	

Table A-23 HDRY signals (continued)

Signal	Odd pins		Even pins	
	Pin	Pin	Pin	Signal
Yx67	45	46	46	Yx112
Yx66	47	48	48	Yx113
Yx65	49	50	50	Yx114
Yx64	51	52	52	Yx115
Yx63	53	54	54	Yx116
Yx62	55	56	56	Yx117
Yx61	57	58	58	Yx118
Yx60	59	60	60	Yx119
Yx59	61	62	62	Yx120
Yx58	63	64	64	Yx121
Yx57	65	66	66	Yx122
Yx56	67	68	68	Yx123
Yx55	69	70	70	Yx124
Yx54	71	72	72	Yx125
Yx53	73	74	74	Yx126
Yx52	75	76	76	Yx127
Yx51	77	78	78	Yx128
Yx50	79	80	80	Yx129
Yx49	81	82	82	Yx130
Yx48	83	84	84	Yx131
Yx47	85	86	86	Yx132
Yx46	87	88	88	Yx133
Yx45	89	90	90	Yx134
Yx44	91	92	92	Yx135

Table A-23 HDRY signals (continued)

Signal	Odd pins		Even pins	
	Pin		Pin	Signal
Yx43	93		94	Yx136
Yx42	95		96	Yx137
Yx41	97		98	Yx138
Yx40	99		100	Yx139
Yx39	101		102	Yx140
Yx38	103		104	Yx141
Yx37	105		106	Yx142
Yx36	107		108	Yx143
Yx35	109		110	Yx144
Yx34	111		112	Yx145
Yx33	113		114	Yx146
Yx32	115		116	Yx147
Yx31	117		118	Yx148
Yx30	119		120	Yx149
Yx29	121		122	Yx150
Yx28	123		124	Yx151
Yx27	125		126	Yx152
Yx26	127		128	Yx153
Yx25	129		130	Yx154
Yx24	131		132	Yx155
Yx23	133		134	Yx156
Yx22	135		136	Yx157
Yx21	137		138	Yx158
Yx20	139		140	Yx159

Table A-23 HDRY signals (continued)

Signal	Odd pins		Even pins	
	Pin		Pin	Signal
Yx19	141		142	Yx160
Yx18	143		144	Yx161
Yx17	145		146	Yx162
Yx16	147		148	Yx163
Yx15	149		150	Yx164
Yx14	151		152	Yx165
Yx13	153		154	Yx166
Yx12	155		156	Yx167
Yx11	157		158	Yx168
Yx10	159		160	Yx169
Yx9	161		162	Yx170
Yx8	163		164	Yx171
Yx7	165		166	Yx172
Yx6	167		168	Yx173
Yx5	169		170	Yx174
Yx4	171		172	Yx175
Yx3	173		174	Yx176
Yx2	175		176	Yx177
Yx1	177		178	Yx178
Yx0	179		180	Yx179

A.3.3 HDRZ

Table A-24 describes the signals on the HDRZ pins.

Table A-24 HDRZ signals

Signal	Pin	Pin	Signal
Z128	1	2	Z255
Z129	3	4	Z254
Z130	5	6	Z253
Z131	7	8	Z252
Z132	9	10	Z251
Z133	11	12	Z250
Z134	13	14	Z249
Z135	15	16	Z248
Z136	17	18	Z247
Z137	19	20	Z246
Z138	21	22	Z245
Z139	23	24	Z244
Z140	25	26	Z243
Z141	27	28	Z242
Z142	29	30	Z241
Z143	31	32	Z240
Z144	33	34	Z239
Z145	35	36	Z238
Z146	37	38	Z237
Z147	39	40	Z236
Z148	41	42	Z235
Z149	43	44	Z234
Z150	45	46	Z233

Table A-24 HDRZ signals (continued)

Signal	Pin	Pin	Signal
Z151	47	48	Z232
Z152	49	50	Z231
Z153	51	52	Z230
Z154	53	54	Z229
Z155	55	56	Z228
Z156	57	58	Z227
Z157	59	60	Z226
Z158	61	62	Z225
Z159	63	64	Z224
Z160	65	66	Z223
Z161	67	68	Z222
Z162	69	70	Z221
Z163	71	72	Z220
Z164	73	74	Z219
Z165	75	76	Z218
Z166	77	78	Z217
Z167	79	80	Z216
Z168	81	82	Z215
Z169	83	84	Z214
Z170	85	86	Z213
Z171	87	88	Z212
Z172	89	90	Z211
Z173	91	92	Z210
Z174	93	94	Z209
Z175	95	96	Z208

Table A-24 HDRZ signals (continued)

Signal	Pin	Pin	Signal
Z176	97	98	Z207
Z177	99	100	Z206
Z178	101	102	Z205
Z179	103	104	Z204
Z180	105	106	Z203
Z181	107	108	ZU202
Z182	109	110	ZU201
Z183	111	112	ZU200
Z184	113	114	ZU199
Z185	115	116	ZU198
Z186	117	118	ZU197
Z187	119	120	ZU196
Z188	121	122	ZU195
Z189	123	124	ZU194
Z190	125	126	ZU193
Z191	127	128	ZU192
D_nSRST	129	130	CLK_POS_DN_IN
D_nTRST	131	132	CLK_NEG_DN_IN
D_TDO_OUT	133	134	CLK_POS_UP_OUT
D_TDI	135	136	CLK_NEG_UP_OUT
D_TCK_IN	137	138	CLK_UP_THRU
D_TMS_IN	139	140	CLK_OUT_PLUS1
D_RTCK	141	142	CLK_OUT_PLUS2
C_nSRST	143	144	CLK_IN_PLUS2
C_nTRST	145	146	CLK_IN_PLUS1

Table A-24 HDRZ signals (continued)

Signal	Pin	Pin	Signal
C_TDO_OUT	147	148	CLK_DN_THRU
C_TDI	149	150	CLK_GLOBAL
C_TCK_IN	151	152	FPGA_IMAGE
C_TMS_IN	153	154	nSYSPOR
GND	155	156	nSYSRST
nCFGEN	157	158	nRTCKEN
GLOBAL_DONE	159	160	SPARE12 (reserved)
SPARE11 (reserved)	161	162	SPARE10 (reserved)
SPARE9 (reserved)	163	164	SPARE8 (reserved)
SPARE7 (reserved)	165	166	SPARE6 (reserved)
SPARE5 (reserved)	167	168	SPARE4 (reserved)
SPARE3 (reserved)	169	170	SPARE2 (reserved)
SPARE1 (reserved)	171	172	SPARE0 (reserved)
Z63	173	174	Z64
Z62	175	176	Z65
Z61	177	178	Z66
Z60	179	180	Z67
Z59	181	182	Z68
Z58	183	184	Z69
Z57	185	186	Z70
Z56	187	188	Z71
Z55	189	190	Z72
Z54	191	192	Z73
Z53	193	194	Z74

Table A-24 HDRZ signals (continued)

Signal	Pin	Pin	Signal
Z52	195	196	Z75
Z51	197	198	Z76
Z50	199	200	Z77
Z49	201	202	Z78
Z48	203	204	Z79
Z47	205	206	Z80
Z46	207	208	Z81
Z45	209	210	Z82
Z44	211	212	Z83
Z43	213	214	Z84
Z42	215	216	Z85
Z41	217	218	Z86
Z40	219	220	Z87
Z39	221	222	Z88
Z38	223	224	Z89
Z37	225	226	Z90
Z36	227	228	Z91
Z35	229	230	Z92
Z34	231	232	Z93
Z33	233	234	Z94
Z32	235	236	Z95
Z31	237	238	Z96
Z30	239	240	Z97
Z29	241	242	Z98
Z28	243	244	Z99

Table A-24 HDRZ signals (continued)

Signal	Pin	Pin	Signal
Z27	245	246	Z100
Z26	247	248	Z101
Z25	249	250	Z102
Z24	251	252	Z103
Z23	253	254	Z104
Z22	255	256	Z105
Z21	257	258	Z106
Z20	259	260	Z107
Z19	261	262	Z108
Z18	263	264	Z109
Z17	265	266	Z110
Z16	267	268	Z111
Z15	269	270	Z112
Z14	271	272	Z113
Z13	273	274	Z114
Z12	275	276	Z115
Z11	277	278	Z116
Z10	279	280	Z117
Z9	281	282	Z118
Z8	283	284	Z119
Z7	285	286	Z120
Z6	287	288	Z121
Z5	289	290	Z122
Z4	291	292	Z123
Z3	293	294	Z124

Table A-24 HDRZ signals (continued)

Signal	Pin	Pin	Signal
Z2	295	296	Z125
Z1	297	298	Z126
Z0	299	300	Z127

A.4 Electrical specification

This section provides details of the voltage and current characteristics for the Analyzer Tile.

A.4.1 Bus interface characteristics

Table A-25 shows the Analyzer Tile electrical characteristics.

Table A-25 Electrical characteristics for 3.3V I/O

Symbol	Description	Min	Max	Unit
V_{IH}	High-level input voltage	2.0	3.6	V
V_{IL}	Low-level input voltage	0	0.8	V
V_{OH}	High-level output voltage	2.4	-	V
V_{OL}	Low-level output voltage	-	0.4	V

A.4.2 Current requirements

Table A-26 shows the current requirements at room temperature and nominal voltage for an Analyzer Tile.

Table A-26 Current requirements

At 3.3V	At 5V
100mA	not used

A.5 Mechanical specification

The Analyzer Tile measurements are shown in Figure A-2.

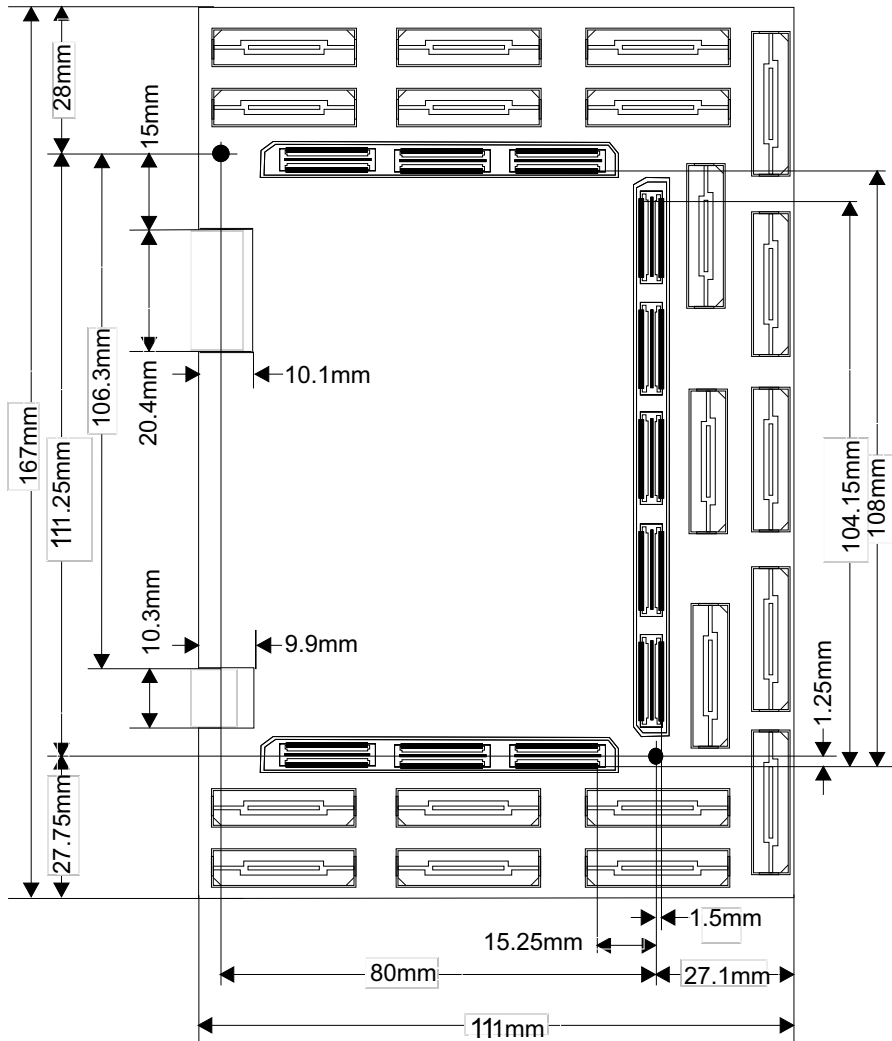

Figure A-2 Analyzer Tile measurements